

Acesonic®



BDK-2000 **Blu-ray Disc Karaoke Player** **User's Manual** V.2



CAUTION:

To assure this player will work at its best, please read this user's manual carefully before operation and keep for future reference.

www.Acesonic.com

Warnings, Cautions and Others

Mises en garde, précautions et indications diverses



Caution
Risk of Electric Shock
Do Not Open



CAUTION: TO REDUCE THE RISK OF ELECTRIC SHOCK,
DO NOT REMOVE COVER (OR BACK).
NO USER SERVICEABLE PARTS INSIDE.
REFER SERVICING TO QUALIFIED SERVICE PERSONNEL.



The lightning flash with arrowhead symbol, within an equilateral triangle is intended to alert the user to the presence of uninsulated dangerous voltage within the product's enclosure that may be of sufficient magnitude to constitute a risk of electric shock to persons.



The exclamation point within an equilateral triangle is intended to alert the user to the presence of important operating and maintenance (servicing) instructions in the literature accompanying the appliance.

CAUTION

To reduce the risk of electrical shocks, fire, etc.:

1. Do not remove screws, covers or cabinet.
2. Do not expose this appliance to rain or moisture.

FCC INFORMATION (U.S.A.)

1. This equipment has been tested and found to comply with the limits for a Class B digital device, pursuant to part 15 of the FCC Rules. These limits are designed to provide reasonable protection against harmful interference in a residential installation.

This equipment generates, uses and can radiate radio frequency energy and, if not installed and used in accordance with the instructions, may cause harmful interference to radio communications. However, there is no guarantee that interference will not occur in a particular installation. If this equipment does cause harmful interference to radio or television reception, which can be determined by turning the equipment off and on, the user is encouraged to try to correct the interference by one or more of the following measures:

Reorient or relocate the receiving antenna.
Increase the separation between the equipment and receiver.

Connect the equipment into an outlet on a circuit different from that to which the receiver is connected. Consult the dealer or an experienced radio/TV technician for help.

2. **IMPORTANT:** When connecting this product to accessories and/or another product use only high quality shielded cables. Cable(s) supplied with this product **MUST** be used. Follow all installation instructions. Failure to follow instructions could void your FCC authorization to use product in the U. S. A.

For Canada/Pour le Canada

CAUTION: TO PREVENT ELECTRIC SHOCK, MATCH WIDE BLADE OF PLUG TO WIDE SLOT, AND FULLY INSERT.

ATTENTION: POUR EVITER LES CHOCS ELECTRIQUES, INTRODUIRE LA LAME LA PLUS LARGE DE LA FICHE DANS LA BORNE CORRESPONDANTE DE LA PRISE ET POUSSER JUSQU'AU FOND.

For Canada/Pour le Canada

THIS DIGITAL APPARATUS DOES NOT EXCEED THE CLASS B LIMITS FOR RADIO NOISE EMISSIONS FORM DIGITAL APPARATUS AS SET OUT IN THE INTERFERENCE-CAUSING EQUIPMENT STANDARD ENTITLED DIGITAL APPARATUS, ICES-003 OF THE DEPARTMENT OF COMMUNICATIONS. CET APPAREIL NUMERIQUE RESPECTE LES LIMITES DE BRUITS RADIO ELECTRIQUES APPLICABLES AUX APPAREILS NUMERQUES DE CLASSE B PRESCRITES DANS LA ORMESUR LE MATERIEL BROUILLEUR: APPAREILS NUMERQUES, NMB-003 EDICTEE PAR LE MINISTRE DES COMMUNICATIONS.

1. CLASS1 LASER PRODUCT

2. **DANGER:** Visible laser radiation when open and interlock has failed or is defeated. Avoid direct exposure to the beam.

3. **CAUTION:** Do not open the top cover. There are no user service able parts inside the unit. Leave all servicing to qualified service personnel.

4. **REPRODUCTION OF LABEL:** CAUTION LABEL, PLACED INSIDE THE UNIT.

Caution

Disconnect the electrical plug to shut off the power completely. The **POWER** on the unit is not off from the electrical plug when the **POWER** button on the front panel is not pressed in.

Important Safety Instructions

1. **Read** These Instructions.
2. **Keep** These Instructions.
3. **Heed** All Warnings.
4. **Follow** All Instructions.
5. **Do not** use this product near water.
6. **Clean** only with dry cloth.
7. **Do not** block any ventilation openings.
8. **Do not** install near any heat sources such as radiators, heat register, stoves, or other apparatus (including amplifiers) that produce heat.
9. **Do not** defeat the safety purpose of the polarized or grounding-type plug. A polarized plug has two blades with one wider than the other. A grounding type plug has two blades and third grounding prong. The wide blade or the third prong are provided for your safety. If the provided plug does not fit into your outlet, consult an electrician for replacement of the obsolete outlet.
10. **Protect** the power cord from being walked on or pinched particularly at plugs, convenience receptacles, and the point where they exit from the apparatus.
11. **Only** use attachments and accessories specified by the manufacturer.
12. **Use** only with the cart, stand, tripod, bracket, or table specified by the manufacturer, or sold with the apparatus. When a cart is used, use caution when moving the cart.
13. **Unplug** this apparatus during lightning storms or unused for long period of time. Apparatus combination to avoid injury from tip-over.
14. **Refer** all servicing to qualified service personnel. Servicing is required when the apparatus has been damaged in any way, such as power-supply cord or plug is damaged, liquid has been spilled or objects have fallen into the apparatus, the apparatus has been exposed to rain or moisture, does not operate normally, or has been dropped.
15. **This** product should be operated only from the type of power source indicated on the marking label. If you are not sure of the type of power supply to your home, consult your product dealer or local power company. For products intended to operate from battery power, or other sources, refer to the operating instructions.
16. **Protective Attachment Plug**
The product is equipped with an attachment plug having overload protection. This is a safety feature. See Instruction Manual for replacement or resetting of protective device. If replacement of the plug is required, be sure the service technician has used a replacement plug specified by the manufacturer that has the same overload protection as the original plug.
17. **Power Lines**
An outside antenna system should not be located in the vicinity of overhead power lines or other electric light or power circuits, or where it can fall into such power lines or circuits. When installing an outside antenna system, extreme care should be taken to keep from touching such power lines or circuits, as contact with them might be fatal.

18. Overloading

Do not overload wall outlets, extension cords, or integral convenience receptacles as this can result in a risk of fire or electric shock.

19. Object and Liquid Entry

Never push objects of any kind into this product through openings as they may touch dangerous voltage points or short-out parts that could result in a fire or electric shock. Never spill liquid of any kind on the product.

20. Replacement Parts

When replacement parts are required, be sure the service technician has used replacement parts specified by the manufacturer or have the same characteristics as the original part. Unauthorized substitutions may result in fire, electric shock, or other hazards.

21. Safety Check

Upon completion of any service or repairs to this product, ask the service technician to perform safety checks to determine that the product is in proper operating condition.

22. Wall or Ceiling Mounting

The product should be mounted to a wall or ceiling only as recommended by the manufacturer. Any mounting of the product should follow the manufacturer instructions, and should use a mounting accessory recommended by the manufacturer.

23. Wet location marking

Apparatus shall not be exposed to dripping or splashing and no objects filled with liquids, such as vases, shall be placed on the apparatus.

24. Outdoor Antenna Grounding

If an outside antenna or cable system is connected to the product, be sure the antenna or cable system is grounded so as to provide some protection against voltage surges and built-up static charges. Article 810 of the National Electrical Code, ANSI/NFPA 70, provides information with regard to proper grounding of the mast and supporting structure, grounding of the lead-in wire to an antenna discharge unit, size of grounding conductors, location of antenna discharge unit, connection to grounding electrodes, and requirements for the grounding electrode. See figure below.

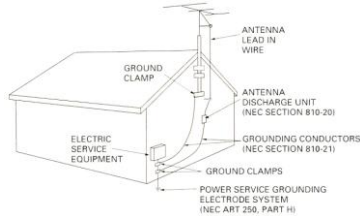

25. Servicing

If your product is not operating correctly or exhibits a marked change in performance and you are unable to restore normal operation by following the detailed procedure in its operating instructions, do not attempt to service it yourself as operating instructions, do not attempt to service it yourself as opening or removing covers may expose you to dangerous voltage or other hazards. Refer all servicing to qualified service personnel.

Acesonic BDK-2000

Included Accessories

Please check that you have all of the following accessories supplied to you. If anything is missing, please contact your dealer immediately.

- *Power Cable
- *Remote Control
- *User's Manual
- *Rack-Mount Kit
- *Warranty Card

About this manual

The display window information and on-screen display (OSD) menu items are all in **bold** lettering.

Precautions

Notes on Power Cord

*When you are away on travel or otherwise for an extended period of time, unplug the unit from the wall outlet.

*When unplugging the player from the wall outlet, always pull the plug, not the cord.

*Do NOT handle the power cord with wet hands.

Avoid Moisture, Water and Dust

*Do not place the player in a moist environment or in area where there might be an excessive amount of dust build up (e.g. near a fan).

*If water or any liquid should get into the unit, turn off the power and unplug the unit from the wall outlet immediately. Consult your dealer or an authorized repair station. Using the unit in this state may lead to fire or electrical shock.

Avoid High Temperatures

*Do not expose the player to direct sunlight or near any heating device.

Notes on Installation

*Select a place where the unit will be level, dry, and not too cold or hot.

*Do not use unit on its side or where subject to vibrations (e.g. speakers).

*Leave sufficient distance between the TV and unit.

* Do not leave heavy objects on top of unit.

Prevent Unit Malfunction

*No parts in this unit are user-serviceable. If the unit no longer functions, unplug it from the wall outlet and contact your dealer for service options.

*Never block the vents on the unit. Vents are used to circulate air and keep the temperature of the player down. Blocking the vents may result in damage of the unit.

Specification:

1 Year Manufacturer Warranty
Lifetime Technical Support
NTSC/PAL Worldwide Compatible
Universal Power Supply: AC100-240V
Player Dimension: 430(W)x240(D)x55(H)mm

WARNINGS, CAUTIONS AND OTHERS 1

IMPORTANT SAFETY INSTRUCTIONS 2

BEFORE OPERATION	1
PLAYER CONNECTIONS	2
FRONT PANEL OPERATION:	3
REAR PANEL OPERATION:	4
REMOTE OPERATION	5
BASIC OPERATIONS	7
DISC USB	8
RECORDING & RIPPING	9
SETUP MENU	10

System Setup -----	10
General-----	10
Screen Saver-----	10
Use Default Settings-----	10
BD Info Storage-----	10
Version-----	11
Software Update-----	11
BD Network Access-----	11
Language-----	11
OSD (On Screen Display) Language-----	12
Subtitle Language-----	12
Network-----	13
Wired-----	13
Parental Control-----	13
Slide-----	14
Video-----	14
Audio-----	15
Bass Management-----	15

TROUBLESHOOTING 15

Before Operation

Playable Media

This unit supports the following formats:

*MP3, WAV, WMA, MPEG-1, MPEG-2 (MPG/VOB), MPEG-4 (AVI), MKV, ISO, JPEG, and MP3G (mp3/cdg) files.

Above media is playable on the following discs:

*Blu-ray™ Discs, BD-ROM, BD-R, BD-RE, DVD, DVD±R, DVD+RW, VCD, CD-DA, CD-R, CD-RW, MP3G, VCDs, CD+Gs, CDs, and Data Discs.

Note: Any disc that is not listed above will cause the player to display "NO DISC" in the DISPLAY WINDOW. Future media and disc formats may be supported with firmware upgrades, when available.

*Encoding methods of some media formats may affect the playback (e.g. Unable to fast forward or fast backward or load time). Be sure that the encoding process conforms to the standards for that particular format.

*Dirty, scratched, warped, and defective discs may cause a considerable time delay during the loading and reading of the disc. In extreme cases, this may render the disc completely unreadable by the player.

Video Signal Formats

This player also accommodates NTSC and PAL color systems, with automatic detection and override settings.

Digital Audio Formats

This player accommodates analog stereo, and few digital Hi-Fi audio signals.

Notes Regarding Discs

*The image may be poor, noisy, or grainy due to actual defects on the disc itself.

*Some functions may not be possible on all discs as described in this manual.

Handling and Cleaning of Discs

Handling

*At anytime, when handling discs, always hold them from their edges and/or by the circle in the center.

*NEVER write on the any surface of the disc for it may render the disc unreadable.

*Store discs in a clean and dry environment. Storing CD's vertically will also help prevent warping.

*After use, insert CD into jacket or case to minimize wear and tear DO NOT stack CDs on top of one another.

*Do not bend or press the disc. Do not expose the disc to direct sunlight or any heat source.

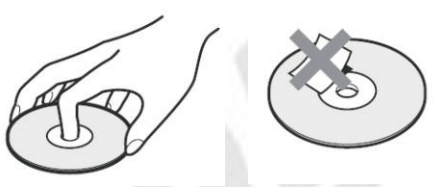

Cleaning

*Wipe the discs from time to time using a soft cloth. Always wipe from the center towards the edges. NOT in circular motions.

*DO NOT clean with any other cleaning solution, unless it is specifically made for disc cleaning.

Note: CD's revolve at very high speeds inside of players. Never attempt to play cracked or warped CD's; doing so may cause the disc to shatter inside or the player to malfunction.

CAUTION

Power-Cord

Handle the power cord only by its plug, do not unplug the power cord by tugging or yanking on the cord. Touching or unplugging the cord while your hands are wet may lead to an electric shock or a short circuit. If the cord becomes damaged or its wires become exposed, please replace the cord as soon as possible in order to prevent an electric fire or shock. Check the power cord every few months to ensure it is functioning properly.

Player Connections

Audio Connections

Line Out Connections

Connect the RCA cable from the Audio L and R outputs of the BDK-2000 to the Line Ins (NOT Phono Ins) on the stereo amplifier or TV. If using a TV that has only 1 input, only connect either the Left or Right Channel. Under some circumstances (such as playing an MP3+G File) you can use the **Audio MPX** button to change the audio to be a mix of left and right channels (mono).

SPDIF Digital Audio

Connect either an RCA coaxial cable from SPDIF Coax Output of the BDK-2000 to the SPDIF Coax Input of the receiver, or use an optical light pipe from the SPDIF optical out of the BDK-2000 to the Optical in.

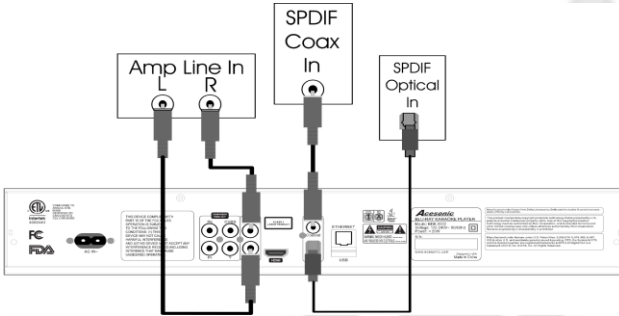

Video Connections

Note: Depending on the specific TV, it may be necessary to change settings in the Setup Menu for the picture to be visible. A standard video monitor or TV hookup may be temporarily necessary in order to make those changes.

HDMI High Def

Connect the HDMI cable from the HDMI Output of the BDK-2000 to the HDMI Input of the Hi Def TV.

Component High Def

Connect the 3 RCA cables from the Component Video Outputs of the BDK-2000 to the Y, Pb, and Pr Inputs on the High Def TV.

Standard NTSC monitor or TV

Connect the single RCA cable from the Video Output of the BDK-2000 to the Video Input on the Standard TV.

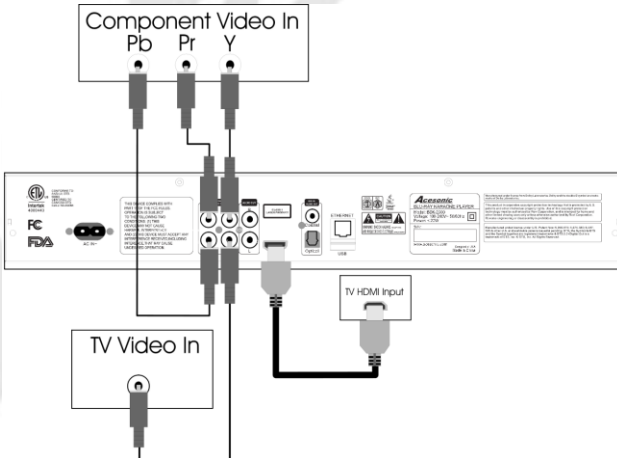

See: **Rear Panel Operations** for more details.

Front Panel Operation:



- 1) **DISPLAY WINDOW** - Displays player status such as time, disc format, and song number. If no disc is in the tray, the display window will display **NO DISC**. Detailed information will also be shown on the TV screen.

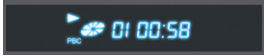

2) **REMOTE SENSOR window** -

Receives signals from remote control. (Underneath display bezel and so not visible here. This is where the remote should be aimed for best operation.)

- 3) **EJECT** - Press to open and close disc tray.



- 4) **Numeric Keypad** - Used to enter numbers as needed.

- 5) **CLEAR** - Press to reset any entered data.



- 7) **GOTO** - Used to go to a specific point during playback.



- 8) **KEY CONTROL** buttons -
button: used to flatten by a half tone.
b button: used to sharpen by a half tone.



MPX - Selects Left/Right, MONO, and Stereo audio output for CDs and audio track for DVDs.



- 9) **PLAY/PAUSE** - Start to play the disc or temporarily suspends playing.



- 10) **MUTE** - Toggles muting on or off.



- 11) **STOP** - Stops playing or recording.



- 12) **Pg Up** - Used to scroll up through file lists one full page at a time.



- 13) **CUE** - Switches the Cue function on and off. When switched on, the cue function will pause playback at the end of the currently playing track.



- 14) **directional buttons** - Press to move through various menus and files. While playing media they also are used as **Fast Forward/Rewind** buttons (directional buttons [**▲/▼**]) and **Chapter Forward/Chapter Backwards** (directional buttons [**▲/▼**]) buttons.



- 15) **RETURN** - This button is used to return to a menu screen while playing.



- 16) **ENTER** - Used to confirm the selection.



- 17) **POWER** - Press the button to turn the unit on or off.

- 18) **MUSIC VOLUME Knob** - Used to control the music level.



- 19) **Pg DN** - Press to scroll down through file lists one full page at a time.

- 20) **Disc Menu** - Returns to the main DVD menu.



- 21) **POP UP MENU** - Press to activate the Blu-Ray Pop Up Menu (if available).



- 22) **TREBLE Knob** - Used to control the amount of Treble or "Highs" in the audio.



- 23) **BASS Knob** - Used to control the amount of Bass or "Lows" in the audio.



- 24) **ECHO knob** - Used to control the amount of ECHO applied to MIC CHANNELS 1 & 2.



- 25) **MIC 1 & 2 VOL knob** - Used to control the volume output from MICCHANNEL 1 & 2.



- 26) **MIC 1 & 2 INPUT jacks** - Connects microphones with 1/4 inch plug.



- 27) **Headphone Jack** - Connects a pair of headphones (With a 1/8" jack) to the unit.



Note: While it is possible to use a set headphones that have a 1/4" jack through an adapter, many adapters are known to cause intermittent problems and their use is not recommended.



- 28) **USB INTERFACE** - Use this interface to connect USB devices such as flash drives or external hard drives.

- 29) **DISC TRAY** - Press to open tray. Press or to close the tray, it will play the disc automatically.



Rear Panel Operation:

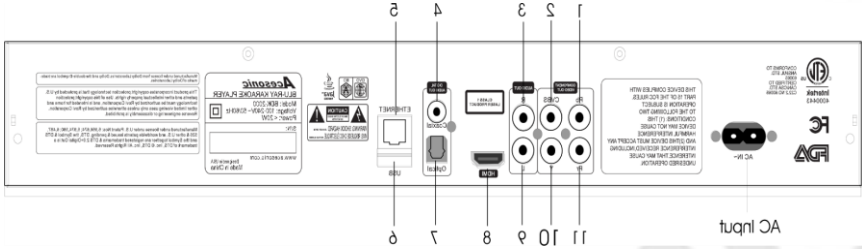

AC Cord Input - Connection to the auto-detect AC power supply (100-240V,50-60 Hz).

Rear Panel Connections

- 1) **Component Video Output (Pb)** Blue Difference channel output.
- 2) **Component Video Output – (CVBS)** Luma (Luminance) output.
- 3) **MIXED AUDIO OUTPUT (R)** – Right channel RCA outputs for mixed vocals and music audio output.
- 4) **COAXIAL OUTPUT** - Coaxial digital output to connect with a digital amplifier or receiver for Dolby Digital or DTS sound.
- 5) **LAN (Local Area Network)** – Connects the BDK-2000 to an Ethernet port.
- 6) **USB Port** - Use this interface to connect USB devices such as flash drives or external hard drives.
- 7) **OPTICAL OUTPUT** – SPDIF Optical output for connection with a digital amplifier or receiver for Dolby Digital or DTS sound.
- 8) **HDMI Video Output** – Used to connect the unit to a High Def. TV through the HDMI input.
- 9) **MIXED AUDIO OUTPUT (L)** – Left channel RCA outputs for mixed vocals and music audio output.
- 10) **Composite Video Output** – (NTSC or PAL output) used to connect to a standard TV through the Video input.
- 11) **Component Video Output – (Pr)** Red Difference channel output.

Remote Control Operations

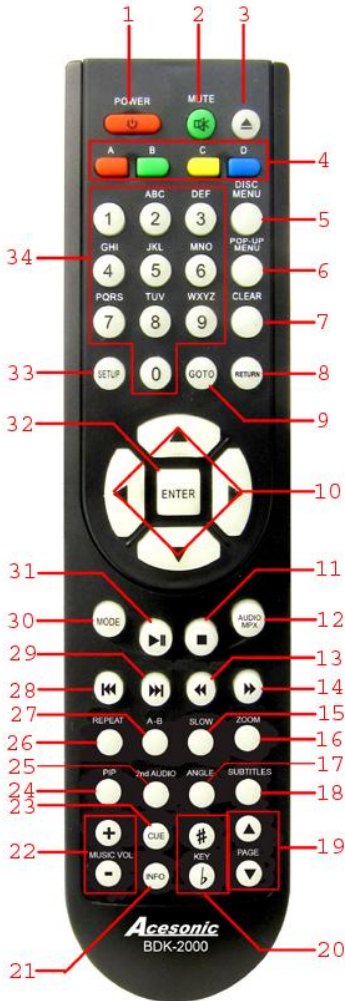

- 1) **POWER BUTTON** - Turns the player on or off.
Note: This merely puts the unit into standby mode.
 To fully power the unit down, manually press the power button on the unit's front panel.



- 2) **MUTE BUTTON** - Turn the sound On or Off



- 3) **EJECT BUTTON** - Used to open and close disc tray



- 4) **Red/Green/Yellow/Blue Function buttons** – Function varies with media



- 5) **DISC MENU** – Press to return to disc's Menu during playback



- 6) **POP-UP MENU** – Press to access Blu-Ray Pop Up Menus (if available)



- 7) **CLEAR** - Used to wipe entry



- 8) **RETURN** - Press to navigate back to previous menu screen



- 9) **GOTO** – Use to jump a specific point during playback.



- 10) **DIRECTIONAL buttons** (▲/▼/◀/▶) - Used for navigation in on-screen menus



- 11) **STOP BUTTON** - Press to end playback



- 12) **AUDIO MPX** - Switch between the Left Mono, Right Mono or Stereo sounds during playback



- 13) **Fast Rewind BUTTON** - Shifts the playback to quick backwards motion



- 14) **Fast Forward BUTTON** - Accelerates playback speed



- 15) **SLOW** – Decelerates playback speed



- 16) **ZOOM BUTTON** - Used to focus on a section of video or picture currently being viewed from a long shot to a close-up



- 17) **ANGLE BUTTON** - Used to select alternate angle views (for DVD enabled discs only)



- 18) **SUBTITLES BUTTON** – Pressing repeatedly will toggle between alternate languages (for DVD enabled discs only)



- 19) **PAGE Up and Down buttons** - Press to scroll through file lists one full page at a time



- 20) **KEY** buttons – Used to raise or lower the pitch
SHARP BUTTON (#) - Raises the key by a half step



Flat button (b) – Lowers the key by a half step

- 21) **INFO BUTTON** - Displays the elapsed or remaining time for single track, file, or the total disc



- 22) **MUSIC VOL. (+/-)** – Adjusts the volume of music audio output.



- 23) **CUE** - Inserts a pause/break between end and start points of track or file. Turning this function off will result in continuous play



- 24) **PIP** – Switches Picture-in-Picture mode on and off.



- 25) **2nd Audio** – Turns SAP mode on and off (when available)



- 26) **REPEAT** – Replays the current playing track



- 27) **A-B BUTTON** - A-B REPEAT allows you to repeat a looped segment of a track until stopped. To use this function:
 1. Set a starting point A.
 2. Set an end point B.
 Afterwards, the unit plays from A to B.
 3. Press A-B again, till A-B disappears.



- 28) **Skip Track Backwards** - Press to go to the beginning previous track or file



- 29) **Skip Track Forward** – Press to go to the beginning of the next track or file



- 30) **Mode** button – Displays the Mode Menu

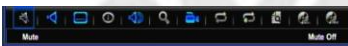

- 31) **Play/Pause BUTTON**- Press the button while the disc is playing, to pause playback.



- 32) **ENTER BUTTON** - Used to confirm entry or selection.



- 33) **SETUP BUTTON**- Press the button to SETUP menu.



- 34) **Numeric Keypad (0-9)** – Used to enter numbers or letters as needed for track or file selection



Basic Operations

Basic Playback

Turn on the BDK-2000.

After a few moments the initial menu screen will appear.



Loading A Disc

1. Press **EJECT** to open the disc tray.
2. Place a disc in the disc tray.
3. Press **EJECT** to close the disc tray.
4. The disc will play automatically.

If A Menu Is Shown On The TV Screen

When inserting a DVD or VCD disc, a menu may be displayed before playback. From the menu, you may select a desired item to be played back.

For DVD Video

1. Use the arrow buttons to select the track desired
2. Press **ENTER** and the player will playback the selected track.

For DVD and Video CD

Use the numeric buttons or directional buttons to navigate and select a desired item:





Confirm using the **ENTER** button to playback.

For CDG and USB

1. Using the numeric buttons, enter the desired file or track number and press **ENTER** to confirm and begin playback.

You may **create a Playlist** by:

1. Pressing the Green function button on the remote control to reserve song(s) 
2. Open the playlist by pressing the Yellow function button 
3. Sort the order preference by moving tracks up the playlist using the Green function button 

Note: To End Playback

Press **STOP** to end playback.

To Resume Playback

On DVDs and VCDs, you can resume playback by pressing the **PLAY** button.

To Stop Playback Completely

Press the **STOP** button twice. Now when you press the **PLAY** button, it will begin from the beginning of the disc. Also, if you eject the disc, the playback completely stops and ejects the disc.

To Pause Playback

Press the **PAUSE** button to pause playback. To resume, press either the **PLAY** or **PAUSE** button.

Note: *Do NOT insert a damaged disc.

*If a disc takes more than usual to read or the **DISPLAY WINDOW** shows **LOAD** for an extended period of time, press **EJECT** on the remote or from the front of the unit and check disc for any dirt/fingerprints or defects.

To Advance Or Reverse Playback While Viewing

During playback on DVDs and VCDs, press **FAST FORWARD**>> or **FAST BACKWARD**<< on the remote unit. You can select from 2 times, 4 times, 8 times, 20 times the normal playback speed.

Karaoke - USING MICROPHONE

The system has 2 microphone inputs. Connect up to 2 microphones to this player.

Karaoke - MICROPHONE MIXER

When a microphone is plugged into **MIC1** or **MIC2**, the system mixes the music with your voice.

1. Press **POWER** button to turn on the system.
2. Load a Karaoke Disc.
3. Press **PLAY** button to start playing.
4. Adjust **MASTER VOLUME** buttons on the remote controller or the **MASTER VOLUME KNOB** on the front panel.
5. Adjust the individual microphone volumes with the **Mic. Volume Knobs** on the front panel.
6. Starting singing while the song is playing.
7. Adjust **ECHO** level with the **ECHO Volume Knob** on the front panel to the desired echo level.

Changing the Batteries in the Remote

The battery compartment is located on the back of the remote control.

1. Open the lid of the remote control battery compartment.
2. Put 2 AAA batteries
Make sure that the batteries are put with the positive and negative terminals in the correct direction corresponding to the (+) and (-) marks in the battery compartment.
3. Install the lid of the remote control battery compartment.

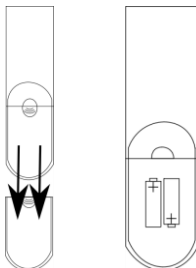

Disc



Navigate to the **Disc** icon using the directional buttons [◀/▶]
Press the **ENTER** button to confirm your selection
Disc will play automatically, if loaded.

USB



Navigate to the **USB** icon using the directional buttons [◀/▶]
Press the **ENTER** button to confirm your selection
Screen will show the root directory of the USB memory device, if one is inserted.

Individual folders can be selected using the directional buttons [▲/▼]

Confirm desired folder by pressing the **ENTER** button or right-directional button [▶]

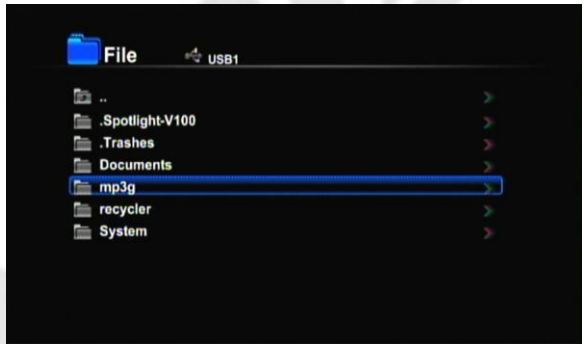

Individual files can be selected using the directional buttons [▲/▼] and confirmed by pressing the **ENTER** or **Play** button.

Compatible file types are:

MP3+G (MP3/CDG), WAV, WMA, MPEG-1, MPEG-2 (MPG/VOB), MPEG-4(AVI/MP4), MKV, JPEG, ISO.



Ripping, Recording and Speech Dictation

Ripping Tracks from CDG into MP3+G



1. Insert a CD+G
2. Press the **SETUP** button on the remote control to launch the Ripping menu
3. Use the directional buttons to highlight the desired track(s) and press **ENTER** to select
4. Select each of the desired tracks to be recorded

To Select All Tracks, simply press the Red function button labeled **A** on the remote control 

5. Select Yellow function button labeled **C** on the remote control to begin the ripping process 

Note: You will see a progress bar on-screen. Do Not remove memory device before completion.

Record Your Singing Performance into MP3

1. Highlight a CD+G or MP3+G song 
2. Press Blue function button labeled **D** on the remote control 
3. When prompted, click on the song name and rename as desired using the on-screen keyboard and selecting **ENTER** key on the screen.
4. Select **OK** prompt
5. Choose the desired storage device and select **ENTER**

Recording a Speech, Dictation or other audio captured by the microphone into MP3

Insert a compatible USB storage device before beginning and microphone into MIC1 and/or MIC2 ports.

1. From the Home Screen, select the **RECORD** icon and press **ENTER** to confirm your selection



A red recording indicator will appear in the upper left-hand of the screen.

2. Begin your dictation by speaking into the microphone
3. Press the **STOP** button to end and finalize your recording.

IMPORTANT: Do Not remove the memory device from the USB port until the Red Recording Indicator has disappeared from the screen. Doing so will risk corrupting the recording process and produce a non-playable file.

Setup menu



System Setup

Note: Pressing the **RETURN** button will revert back to previous menu-level/screen.

- 1) Navigate to the **Setup** Icon by using the directional buttons [◀/▶]
- 2) Press the **ENTER** button to confirm your selection



General

Screen Saver

This setting allows you to turn the floating **ACESONIC** logo to after a period of inactivity.

Select **On** to enable

Select **Off** to disable

Note: Screen Saver is set to begin after 3 Minutes of inactivity.

Use Default Settings

Selecting this option will restore all preferences to original factory defaults.

BD Info Storage

Displays amount of memory and space available among memory devices that are plugged into USB ports:

NAND: Displays the amount memory and space available within BDK-2000 if/when no USB memory device is present. **Note:** This memory is not for file storage, but rather operating system for system functions and buffer.

USB1: Displays the total amount of memory and space remaining within the 1st USB device inserted in either front or back USB port.

USB2: Displays the total amount of memory and space remaining if there is a 2nd USB device inserted in either front or back USB port.

Format

USE THIS FUNCTION WITH EXTREME CAUTION!

This procedure will completely erase **ALL** previously stored data/files on the device.

Note: You will be prompted to confirm after selecting this function and screen will revert to the previous menu unless “Yes” is selected within 30 seconds to prevent accidental erasure.

Free Space

Displays the total amount of memory available for storage in the currently selected device.

Total Space

Displays to total memory size of the currently selected device.

Version

Displays the version of your player's operating system that is currently installed. Keeping this version current will ensure your player has the latest features and bug fixes.

Firmware updates can be found at <http://www.acesonic.com/bdk2kfirmware.html>

Software Update

- 1) You will need to have the software loaded on a USB memory device and select when prompted to **Choose device** (USB1, USB2, or Disc)
- 2) Use directional buttons [**▲/▼**] to select "Disc" or "USB" depending on where you loaded the firmware. Press "Enter" to confirm your selection.

Selecting **Cancel** will exit the **Software Update** process.

The unit will display a progress screen as it updates the internal memory.

It is recommended that when the process is complete, the unit is completely powered off for 5 minutes before turning back on and factory settings restored.

(**SETUP>GENERAL>USE DEFAULT SETTINGS** menu)



BD Network Access

- 1) Press the directional buttons [**▲/▼**] to select "**BD Network Access**"
- 2) Press the **ENTER** button or directional button [**▶**] to select the **Sub-Menu**.
- 3) Press the directional buttons [**▲/▼**] to select "**Allowed**" or "**Not Allowed**"
- 4) Press the **ENTER** button to confirm it

Bitrate

Changing these settings will alter the number of bits-per-second encoded into the mp3 file that is produced when ripping or recording on your BDK-2000.

128-160Kbps ranges will usually result in sound quality equivalent to what you'd hear on the radio.

192-320Kbps ranges will usually result in sound quality closer to that of a CD

Note: Lower bitrate speeds will best maximize memory threshold of the device or disc where the file is stored, while higher bitrate speeds will result in less song capacity of memory device or disc.

Ripping Speed

Changing these settings will alter the writing speed of the mp3 file that is produced when ripping on your BDK-2000.

1x is equivalent to real-time speed at highest quality.

4x is averaged to about 25-35% of the actual song's length.

Note: Discs by various labels can react differently to the ripping process and as such, not all discs can be guaranteed against having an adverse effect on the ripping process. For best results, it is suggested to use 128 Kbps at 1x ripping speed, particularly if experiencing issues ripping of a particular disc or track.



Language

- 1) Press the directional buttons [▲/▼] to select **"Language"**
- 2) Press the **ENTER** button or right-directional button [▶] to confirm it.

OSD (On Screen Display) Language

- 1) Press the directional buttons [▲/▼] to select **"OSD Language"**
- 2) Press the **ENTER** button or right-directional buttons [▶] to select the **Sub-Menu**.
- 3) Press the directional buttons [▲/▼] to select **"English", "Francais", or "Español"**
- 4) Press the **ENTER** button to confirm it.

Disc Audio

- 1) Press the directional buttons [▲/▼] to select **"Disc Audio"**
- 2) Press the **ENTER** button or right-directional button [▶] to select the **Sub-Menu**.
- 3) Press the directional buttons [▲/▼] to select **"English", "German", "French", "Italian", "Spanish", "Portuguese", "Chinese."**
- 4) Press the **ENTER** button to confirm it.

Subtitle Language

- 1) Press the directional buttons [▲/▼] to select **"Disc Audio"**
- 2) Press the **ENTER** button or right-directional button [▶] to select the **Sub-Menu**.
- 3) Press the directional buttons [▲/▼] to select **"English", "German", "French", "Italian", "Spanish", "Portuguese", "Chinese", or "None"**

Note: The available options will depend on the disc currently in the unit.

- 4) Press the **ENTER** button to confirm it.

Disc Menu

- 1) Press the directional buttons [▲/▼] to select **"Disc Menu"**
- 2) Press the **ENTER** button or right-directional buttons [▶] to select the **Sub-Menu**.
- 3) Press the directional buttons [▲/▼] to select **"English", "German", "Portuguese", or "Chinese"**.

Note: The available options will depend on the disc currently in the unit.

- 4) Press the **ENTER** button to confirm it.

Default Subtitles

- 1) Press the directional buttons [▲/▼] to select **"Default Subtitles"**
- 2) Press the **ENTER** button or right-directional button [▶] to select the **Sub-Menu**.
- 3) Press the directional buttons [▲/▼] to select **"Unicode", "Central", "Russian", "Greek", "Hebrew", "Turkish", "Windows EU", "Windows CR", "GB2312", or "BIOS"**
- 4) Press the **ENTER** button to confirm it.



Network

- 1) Press the directional buttons [**▲/▼**] to select "**Network**".
- 2) Press the **ENTER** button or right-directional button [**▶**] to confirm it.

Wired

- 1) Press the directional buttons [**▲/▼**] to select "**Wired**".
- 2) Press the **ENTER** button or right-directional button [**▶**] to select the **Sub-Menu**.

Auto Configuration

- 1) Press the directional buttons [**▲/▼**] to select "**Auto Configuration**".
- 2) Press the **ENTER** button or right-directional button [**▶**] to select the **Sub-Menu**.
- 3) The Auto configuration will run automatically.

Advanced Settings

- 1) Press the directional buttons [**▲/▼**] to select "**Advanced Settings**".
- 2) Press the **ENTER** button or right-directional button [**▶**] to select the **Sub-Menu**.
- 3) Press the directional buttons [**▲/▼**] to select "**PPPOE/ADSL**", or "**Fixed IP Address**".
- 4) Press the **ENTER** button to confirm it.

Mac Address

Displays the current Media Access Control address

IP Address

Displays the current Internet Protocol Address

Subnet Mask

Displays the current subnetwork. This is a logically visible subdivision of an Internet Protocol (IP) network.

Default Gateway

Displays the current address of your router on a TCP/IP network that serves as an access point

Parental Control

- 1) Press the directional buttons [**▲/▼**] to select "**Parental Control**".
- 2) Press the **ENTER** button or right-directional button [**▶**] to select the **Sub-Menu**.
- 3) Press the numeric buttons to enter the current password (default is 66666).
- 4) Press the **ENTER** button to confirm it.

Rating Level

- 1) Press the directional buttons [**▲/▼**] to select "**Rating Level**".
- 2) Press the **ENTER** button or right-directional button [**▶**] to select the **Sub-Menu**.
- 3) Press the right-directional button [**▲/▼**] to select "**1 (Kids)**", "**2 (G)**", "**3 (PG)**", "**4 (PG-13)**", "**5 (PG-R)**", "**6 (R)**", "**7 (NC-17)**", or "**8 (Adults)**".
- 4) Press the **ENTER** button to confirm it.

Change Password

- 1) Press the directional buttons [**▲/▼**] to select "**Change Password**".
- 2) Press the **ENTER** button or right-directional button [**▶**] to select the **Sub-Menu**.
- 3) Press the numeric buttons to enter the new password.
- 4) Press the **ENTER** button to confirm it.
- 5) Press the numeric buttons to re-enter the new password.
- 6) Press the **ENTER** button to confirm it.

Note: Pressing the **RETURN** button will exit the password entry screen and return to the **Parental Control Sub-Menu**.



Slide

- 1) Press the directional buttons [▲/▼] to select "**Slide**".
- 2) Press the **ENTER** button or direction button [▶] to confirm it.

Transition Mode

- 1) Press the directional buttons [▲/▼] to select "**Transition Mode**".
- 2) Press the **ENTER** button or right-directional button [▶] to select the **Sub-Menu**.
- 3) Press the directional buttons [▲/▼] to select "**None**", "**Slide**", "**Stripes**", "**Fade**", "**Wipe**", or "**Random**".
- 4) Press the **ENTER** button to confirm it.

Slide Interval Time

- 1) Press the directional buttons [▲/▼] to select "**Slide**".
- 2) Press the **ENTER** button or right-directional button [▶] to select the **Sub-Menu**.
- 3) Press the directional buttons [▲/▼] to select "**5 Seconds**", "**10 Seconds**", "**30Seconds**", or "**1Minute**".
- 4) Press the **ENTER** button to confirm it.



Video

Note! Use these features with extreme CAUTION! Incorrect settings can cause the picture to become unstable and impossible to read.

- 1) Press the directional buttons [▲/▼] to select "**Video**".
- 2) Press the **ENTER** button or right-directional buttons [▶] to confirm it.

TV System

- 1) Press the directional buttons [▲/▼] to select "**TV System**".
- 2) Press the **ENTER** button or right-directional buttons [▶] to select the **Sub-Menu**.
- 3) Press the directional buttons [▲/▼] to select "**NTSC**", "**PAL**", or "**Auto**".
- 4) Press the directional buttons [◀/▶] to select "**Yes**", or "**No**" on the confirmation Screen.
- 5) Press the **ENTER** button to confirm it.

Resolution

- 1) Press the directional buttons [▲/▼] to select "**Resolution**".
- 2) Press the **ENTER** button or right-directional [▶] to select the **Sub-Menu**.
- 3) Press the directional buttons [▲/▼] to select "**480i/480p**", "**720p/1080i**", "**1080p**", or "**HDMI Native · 1080i**".
- 4) Press the **ENTER** button to confirm it.

Video Out

- 1) Press the directional buttons [▲/▼] to select "**Video Out**".
- 2) Press the **ENTER** button or right-directional [▶] to select the **Sub-Menu**.
- 3) Press the directional buttons [▲/▼] to select "**RGB**", "**Component SD**", or "**Component HD**".
- 4) Press the **ENTER** button to confirm it.

Subtitle Setup

- 1) Press the directional buttons [▲/▼] to select "**Subtitle Setup**".
- 2) Press the **ENTER** button or right-directional [▶] to select the **Sub-Menu**.

Font Size

- 1) Press the directional buttons [▲/▼] to select "**Font Size**".
- 2) Press the **ENTER** button or right-directional [▶] to select the **Sub-Menu**.
- 3) Press the directional buttons [▲/▼] to select "**Big**", "**Middle**", or "**Small**".
- 4) Press the **ENTER** button to confirm it.

Font Colour

- 1) Press the directional buttons [▲/▼] to select "**Font Colour**".
- 2) Press the **ENTER** button or right-directional [▶] to select the **Sub-Menu**.
- 3) Press the directional buttons [▲/▼] to select "**White**", "**Red**", "**Yellow**", "**Green**", "**Blue**", or "**Gray**".
- 4) Press the **ENTER** button to confirm it.
- 5) Press the left-directional button [◀] button to return to the **Subtitle Setup Sub Menu**.

Time Shift

- 1) Press the directional buttons [**▲/▼**] to select "**Font Colour**".
- 2) Press the **ENTER** button or right-directional [**▶**] to select the **Sub-Menu**
- 3) Press the directional buttons [**▲/▼**] to adjust **-99 to +99 seconds**.

TV Display

- 1) Press the directional buttons [**▲/▼**] to select "**TV Display**".
- 2) Press the **ENTER** button or right-directional [**▶**] to select the **Sub-Menu**.
- 3) Press the directional buttons [**▲/▼**] to select "**4:3 Letterbox**", "**4:3 Pan Scan**", or "**16:9**".
- 4) Press the **ENTER** button to confirm it.



Audio

- 1) Press the directional buttons [**▲/▼**] to select "**Audio**".
- 2) Press the **ENTER** button or right-directional button [**▶**] to confirm it.

Bass Management

Note: (only available if 5.1 or 2.1 surround sound is active)

- 1) Press the directional buttons [**▲/▼**] to select "**Bass Management**".
- 2) Press the **ENTER** button or right-directional button [**▶**] to select the **Sub-Menu**.
- 3) Press the directional buttons [**▲/▼**] to select "**On**" or "**Off**".
- 4) Press the **ENTER** button to confirm it.

Center Speaker **Note:** (only available if 5.1 surround sound is active)

- 1) Press the directional buttons [**▲/▼**] to select "**Center Speaker**".
- 2) Press the **ENTER** button or right-directional button [**▶**] to select the **Sub-Menu**.
- 3) Press the directional buttons [**▲/▼**] to select "**Large**" or "**None**".
- 4) Press the **ENTER** button to confirm it.

Surround Speakers **Note:** (only available if 5.1 surround sound is active)

- 1) Press the directional buttons [**▲/▼**] to select "**Surround Speakers**".
- 2) Press the **ENTER** button or right-directional button [**▶**] to select the **Sub-Menu**.
- 3) Press the directional buttons [**▲/▼**] to select "**Large**" or "**None**".
- 4) Press the **ENTER** button to confirm it.

Subwoofer **Note:** (only available if 5.1 or 2.1 surround sound is active)

- 1) Press the directional buttons [**▲/▼**] to select "**Subwoofer**".
- 2) Press the **ENTER** button or right-directional button [**▶**] to select the **Sub-Menu**.
- 3) Press the directional buttons [**▲/▼**] to select "**Present**" or "**None**".
- 4) Press the **ENTER** button to confirm it.

Test Tones

- 1) Press the directional buttons [**▲/▼**] to select "**Test Tones**".
- 2) Press the **ENTER** button or right-directional button [**▶**] to select the **Sub-Menu**.
- 3) Press the directional buttons [**▲/▼**] to select "**On**" or "**Off**".
- 4) Press the **ENTER** button to confirm it.

Digital Output

- 1) Press the directional buttons [**▲/▼**] to select "**Digital Output**".
- 2) Press the **ENTER** button or right-directional button [**▶**] to select the **Sub-Menu**.
- 3) Press the directional buttons [**▲/▼**] to select "**Off**", "**PCM**" (Pulse Code Modulation), or "**Raw**".
- 4) Press the **ENTER** button to confirm it.

Dynamic Range

- 1) Press the directional buttons [**▲/▼**] to select "**Dynamic Range**".
- 2) Press the **ENTER** button or right-directional button [**▶**] to select the **Sub-Menu**.
- 3) Press the directional buttons [**▲/▼**] to select "**On**", "**Off**", or "**Auto**".
- 4) Press the **ENTER** button to confirm it.

Audio Output

- 1) Press the directional buttons [**▲/▼**] to select "**Audio Output**".
- 2) Press the **ENTER** button or right-directional button [**▶**] to select the **Sub-Menu**.
- 3) Press the directional buttons [**▲/▼**] to select "**5.1 Channel**", "**2.1 Channel**", or "**2.0 Channel**".
- 4) Press the **ENTER** button to confirm it.

Troubleshooting

Incorrect operations are often mistaken for trouble and malfunctions. If you suspect that something is wrong with the unit, check the list below, for sometimes the troubles lie within another component. Remember to try inspecting other components

and electrical appliances in use. If the trouble cannot be rectified even after exercising the steps listed below, call our Acesonic service center +1-626-820-0670 to inquire about repairs.

	Symptom	Possible Causes and Solutions
Reset to Factory Settings	Resetting the unit to factory defaults will likely solve more than 90% of problems encountered.	<ol style="list-style-type: none"> 1. Remove any disc from Disc Tray. 2. Power the unit down then back up using the front panel Power Switch (not the remote). 3. Power the unit back up. 4. Restore the factory settings through the setup menu. Setup>Use Default Settings
Operation	The Disc automatically ejects back out when the DVD tray is closed.	Dirty or Warped Disc. The Disc was not seated properly on the Disc Tray. Region No. on the disc does not conform to the unit.
	Cannot execute playback.	Condensation has formed inside the player
	Video playback stops and the operation buttons cannot be used.	Press the STOP button. Press the PLAY button to restart playback.
	Picture disturbance during playback.	This player is compatible with Macro-Vision System copy guard. Some discs include a copy prevention signal, and when this type of disc is played back, stripes etc., may appear on some sections of the picture depending on the TV. (This is not a malfunction)
	When recorded on a VCR there is a disturbance in the playback picture.	This player is compatible with copy prevention technology. Some discs include a copy prevention signal and the copy guard system will prevent proper playback.
	Remote is not functioning.	The remote control is too far from the player, or the angle with the remote sensor is too sharp. The batteries are exhausted (dead). Try fresh batteries. There is an object between the remote control and the sensor. The batteries are incorrectly positioned in the remote. Remove and reseat the batteries.
	Improper operation of TV set, etc, occurs.	Some TVs that have wireless remote control functions may not operate properly with this remote control.
	No audio or distorted sound.	Digital signal is prohibited for some discs. The connection [lugs are not inserted fully into the jacks or are not connected at all. The connection plug or jack is dirty. Check the Jacks and plugs for dirt. Audio cable connection is incorrect. Connection is made to the stereo amplifier's PHONO connection. Try connecting to a LINE in connection instead. The PAUSE mode is engaged. Stereo amplifier operation is incorrect. Check the settings for the stereo (Input source, volume, etc.)
	Noticeable difference in DVD and CD volume.	Although you may notice a difference in volume between CDs and DVDs, this is a result of differences in disc recording methods.
		Mic Delay via HDMI Receiver or TV Tuner
Karaoke Operations.	There's no sound from the microphone.	Unit is not correctly connected to a stereo amplifier or TV. See Player Connections. PAGE 4 The Mic. Level is too low. Adjust the level for the Mic that is plugged in. The mic. Is turned off. Many mic.s have an on/off switch.
	There's feedback and screeching.	The Microphone is too close to the speakers. Move the mic further away or lower the volume of the mic input.
Video	Screen is black and white, wavy, or contains static.	The unit is in the wrong video mode.
USB devices.	The unit cannot read the devices.	The device may be incompatible.

***Caution**

Abnormal activity of the unit can be caused by static electricity, or other external interference.
To restore normal operation, unplug the AC power cord and plug it in again.

NOTES

Acesonic

ACESONIC USA CORP.
City of Industry CA, U.S.A
Customer service: +1626 820
0670
www.acesonic.com

