

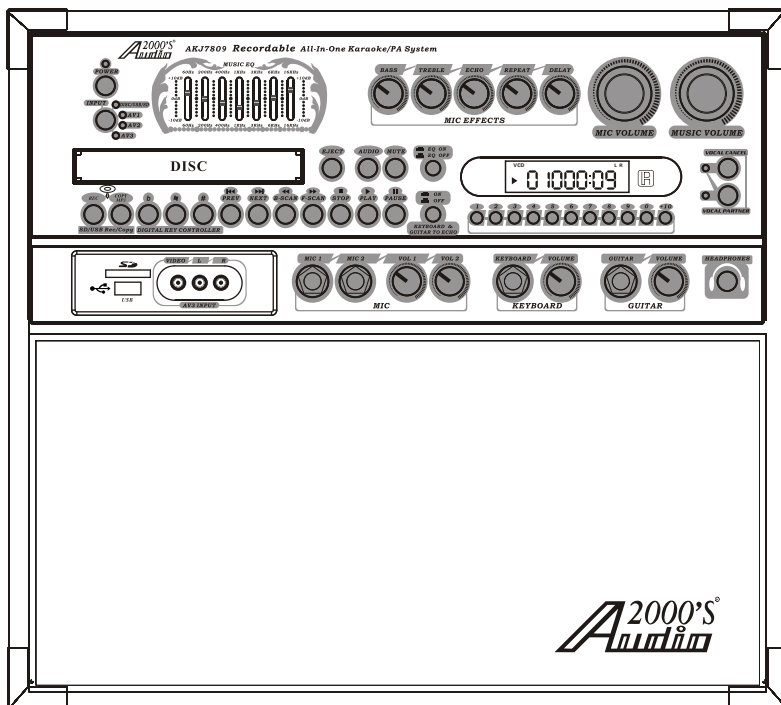

RECORDABLE ALL-IN-ONE KARAOKE/PA SYSTEM

**AKJ7809
OWNER'S MANUAL**



Thank you for purchasing the Audio2000'S® AKJ7809 recordable all-in-one karaoke/PA system! For the best results and the utmost satisfaction from your new unit, please read this manual thoroughly, and retain it for future reference.

Table of Contents

Safety instructions	1
Features	3
Specifications	4
Package contents.....	4
Basic Connections:	
●Connecting to the AC outlet	5
●Connecting to a TV / video monitor with a RCA input	5
●Connecting to an audio mixer or TV with RCA audio inputs	6
DVD Output Connections:	
●Connecting to a Dolby Pro logic amplifier.....	7-8
●Connecting to a TV with component video.....	8
●Connecting to a DTS receiver/decoder.....	9
General Connections:	
●AV input connections	9
●Headphones connections	10
●Microphone/instrument input connections	10
General Operations:	
●Turning the AKJ7809 On, Off and to Standby	11
●Input channels	11
●Adjusting the master Music volume	11
●Adjusting the master Microphone volume	11
●Adjusting the master MUSIC EQ	12
●Changing the video mode (PAL / NTSC)	12
Operations (Disc Mode):	
●Loading a disc	12
●Playing a disc	12
●Stopping a disc	12
●Pausing a disc	12
●Skipping tracks/chapters	12
●Searching through a track/chapter	12
●Subtitles	12
●Viewing multiple angles	12
●Slow-motion playback using the SLOW button	12
●Viewing one frame at a time using the STEP button	13
●Selecting repeat options	13
●Creating a loop using the A-B button	13
●Canceling vocals using the L/R button	13
●Zooming in and out	13
●Jumping to specific time on a disc	13
●Viewing and setting the On Screen Display (OSD)	14
●Turning on the last memory function.....	14
PROG (Program) Operations:	
●CD, CDG and VCD Playback.....	14
●DVD Playback.....	15

Table of Contents

Operations (MP3 and AVI/DivX):

- To play a file15
- Direct track access15
- Repeat options 15

USB and SD card operations (disc mode)

- Using the USB input16
- Using the SD card slot16

USB and SD Card REC / COPY Operations

- REC (Record) Operations.....16
- COPY Operations (from CD or CDG to USB or SD Card)..... 17
- COPY Operations (from MP3 to USB or SD Card)..... 17

Microphone Operations :

- Turning on the Microphones18
- Adjusting the master Microphone volume18
- Adjusting the individual Microphone volume controls18
- Adjusting the Microphone tone18
- Using digital Echo19
- Adjusting the KEYBOARD volume19
- Adjusting the GUITAR volume19

Descriptions and Functions:

- Front Panel20
- Rear Panel23
- Remote Control25

DVD System Setup Menu:

- System Setup28
- Language Setup..29
- Audio Setup.....29
- Video Setup.....29
- Speaker Setup30
- Digital Setup30



Troubleshooting31

Service Information32

Safety instructions

WARNING

- * TO PREVENT FIRE OR SHOCK HAZARD. DO NOT EXPOSE THIS APPLIANCE TO RAIN OR MOISTURE.
- * THIS APPLIANCE SHALL NOT BE EXPOSED TO DRIPPING OR SPLASHING WATER AND THAT NO OBJECT FILLED WITH LIQUIDS SUCH AS VASES SHALL BE PLACED ON APPARATUS.

 <p>This lightning flash with arrowhead symbol, within an equilateral triangle, is intended to alert the user to the presence of uninsulated "dangerous voltage" within the product's enclosure that may be of sufficient magnitude to constitute a risk of electric shock to persons.</p>	<p>CAUTION</p> <p>RISK OF ELECTRIC SHOCK DO NOT OPEN</p> <p>Warning: To reduce the risk of electric shock, do not remove cover (or back) no user-serviceable parts inside. Refer servicing to qualified service personnel.</p>	 <p>The exclamation point within an equilateral triangle is intended to alert the user to the presence of important operating and maintenance (servicing) instructions in the literature accompanying the appliance.</p>
---	---	---

IMPORTANT SAFETY INSTRUCTIONS

- 1) Read these instructions.
- 2) Keep these instructions.
- 3) Heed all warnings.
- 4) Follow all instructions.
- 5) Do not use this apparatus near water.
- 6) Clean only with dry cloth.
- 7) Do not block any ventilation openings. Install in accordance with the manufacturer's instructions.
- 8) Do not install near any heat sources such as radiators, heat registers, stoves, or other apparatus (including amplifiers) that produce heat.
- 9) Do not defeat the safety purpose of the polarized or grounding-type plug. A polarized plug has two blades with one wider than the other. A grounding type plug has two blades and a third grounding prong. The wide blade or the third prong are provided for your safety. If the provided plug does not fit into your outlet, consult an electrician for replacement of the obsolete outlet.
- 10) Protect the power cord from being walked on or pinched particularly at plugs, convenience receptacles, and the point where they exit from the apparatus.
- 11) Only use attachments/accessories specified by the manufacturer.
- 12) Use only with the cart, stand, tripod, bracket, or table specified by the manufacturer, or sold with the apparatus. When a cart is used, use caution when moving the cart/apparatus combination to avoid injury from tip-over.



Safety instructions

- 13) Unplug this apparatus during lightning storms or when unused for long periods of time.
- 14) Refer all servicing to qualified service personnel. Servicing is required when the apparatus has been damaged in any way, such as power-supply cord or plug is damaged, liquid has been spilled or objects have fallen into the apparatus, the apparatus has been exposed to rain or moisture, does not operate normally, or has been dropped.
- 15) Grounding or Polarization This product may be equipped with a polarized alternating current line plug (a plug having one blade wider than the other). This plug will fit into the power outlet only one way. This is a safety feature. If you are unable to insert the plug fully into the outlet, try reversing the plug. If the plug should still fail to fit, contact your electrician to replace your obsolete outlet. Do not defeat the safety purpose of the polarized plug.
- 16) Ventilation Slots and openings in the cabinet are provided for ventilation and to ensure reliable operation of the product and to protect it from overheating, and these openings must not be blocked or covered. The openings should never be blocked by placing the product on a bed, sofa, rug, or other similar surface. This product should not be placed in a built-in installation such as a bookcase or rack unless proper ventilation is provided or the manufacturer's instructions have been adhered to.
- 17) The MAINS plug or an appliance coupler is used as the disconnect device, the disconnect device shall remain readily operable.

Class 1 Laser Product

CAUTION: USE OF ANY CONTROLS, ADJUSTMENTS, OR PROCEDURES OTHER THAN THOSE SPECIFIED HEREIN MAY RESULT IN HAZARDOUS RADIATION EXPOSURE.

PRODUCT COMPLIES WITH DHHS RULE 21 CFR SUBCHAPTER J IN EFFECT AT DATE OF MANUFACTURE.

CAUTION: INVISIBLE LASER RADIATION WHEN OPEN. DO NOT STARE INTO BEAM.

Class II equipment symbol 
**This symbol indicates that the unit has
a double insulation system**

Features

Features

1. The "REC" button at the front panel provides the capacity to record the mixed music and microphone sound to the USB or the SD card.
2. The "COPY" button at the front panel copies music files to the USB or the SD card.
3. The built-in USB and SD card readers play VCD, WMA, AVI, MP4, DAT, MPG, and JPG files in USB and SD card.
4. A multi-format player with the direct track access supports DVD, CDG, DVD-R, DVD-RW, VCD, MP4, DIVX, Photo-CD, CD, CD-R, and CD-RW formats.
5. All-in-one design delivers 100W of power through a 4-speaker cabinet.
6. ¼-inch guitar and keyboard inputs with individual volume controls.
7. Digital echo with repeat and delay controls for vocal enhancement.
8. Digital key control (This feature is not applicable to the AUX inputs-AV1, AV2, and AV3).
9. Vocal cancel and vocal partner modes for canceling vocals from multiplexed media.
10. 7-band equalizer.
11. Three RCA audio-video inputs (AV1, AV2, and AV3).
12. Two microphone inputs (MIC1 and MIC2) with individual volume controls (two unbalanced ¼-inch microphone inputs at the front panel and two balanced microphone inputs at the rear panel).
13. Two RCA audio-video outputs, one stereo ¼-inch audio pre-out, and DVD 5.1 audio-video outputs.
14. Three effect inserts (GUITAR, KEYBOARD, and MIC).
15. One ¼-inch stereo headphone output.
16. Remote Control.
17. 115V / 230V and NTSC-PAL compatible for worldwide use.

Specifications and Package contents

Specifications

- AC input voltage AC 115V 60Hz/AC 230V 50Hz
- Audio output power 100 W (peak to peak)
- AV1 Audio input sensitivity 500 mV
- Video input sensitivity 1 V (peak to peak)
- Microphone input sensitivity 8 mV
- Keyboard/Guitar input sensitivity 8 mV
- Video output level 1 V (peak to peak)
- Audio output level 1000 mV
- S/N Ratio 90 dB
- Dimension 18.3" x 12.8" x 16.5" (L x W x H)
- Weight 35.4 lbs

Package Contents

Items	Quantities
AKJ7809 Unit	(1)
A/V RCA Cable	(1)
Microphones	(2)
Microphone Cables	(2)
Remote Control	(1)
AC Power Cord	(1)
AAA Batteries	(2)

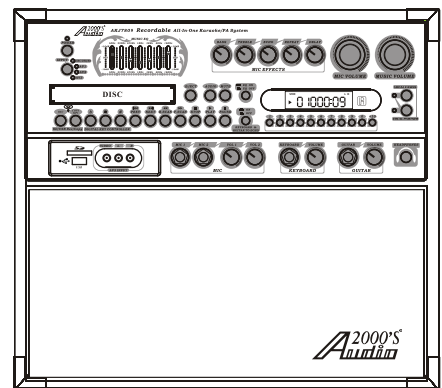

AKJ7809 Unit(1)

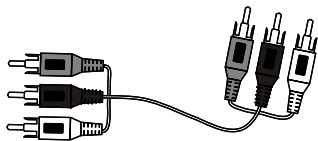

A/V RCA Cable (1)

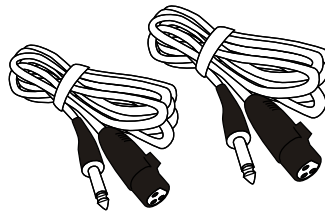

Microphone Cables (2)

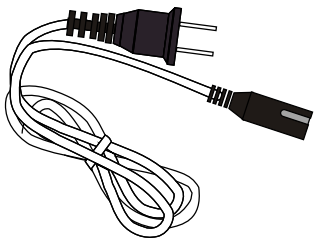

AC Power Cord (1)

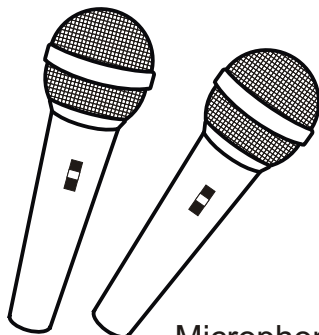

Microphones (2)

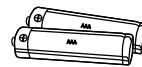

AAA Batteries (2)



Remote Control (1)

Note

If you find that any of the items mentioned above are missing from the box, please contact **AUDIO2000'S®** before proceeding.

Basic Connections

Since the AKJ7809 contains built-in power amplifiers, speakers, DVD/CDG/CD player, USB player, and SD card player, the AKJ7809 can be used as a self-contained sound system. However, the AKJ7809 contains various audio video outputs to allow the AKJ7809 to be connected to multiple TV sets, external sound systems, and/or multiple sound effect devices. The following content demonstrates the procedures for connecting the AKJ7809 to the AC outlet and other audio video devices.

Connecting to the AC outlet

To power the AKJ7809

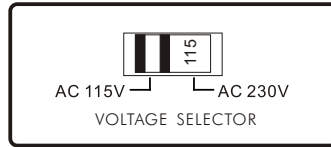

[Fig. A]

What you will need

- AC power cord (included)
- Surge-protector (recommended) or a power outlet

Note: Before turning on the power make sure the red voltage selector [Fig. A] under the AC input is set to the proper voltage. It should be set to 115V for North America and 230V for most European countries. Make sure you know the proper voltage for your region before turning on the AKJ7809.

1. Connect the AC end of the power cord into the AC input on the rear panel of the AKJ7809
2. Connect the other end to a surge-protector or available power outlet

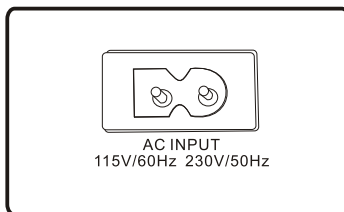

Connecting to a TV / video monitor with a RCA input

What you will need

- 1 RCA-style video cable (included)
- TV / video monitor with a RCA video input

1. Connect one end of the RCA video cable to the yellow Video Out on the rear panel of the AKJ7809.
2. The AKJ7809 has two RCA-type VIDEO OUTPUT jacks for connecting to TVs or monitor devices. Both VIDEO OUTPUTS can be connected simultaneously.
3. Connect the other end of the RCA video cable to the Video Input on a TV / video monitor

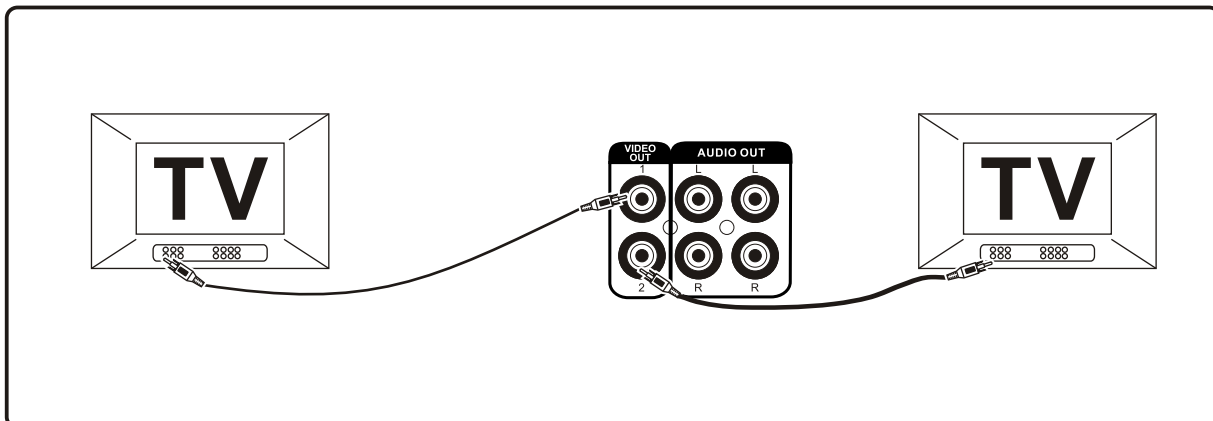

Basic Connections

Connecting to an audio mixer or TV with RCA audio inputs

What you will need

- using 1 RCA L/R (red & white) stereo RCA cable (included)
- using two XLR-type audio cables(not included)
- using two ¼ inch audio cables (not included).
- using three ¼ inch stereo audio cables (not included).
- using one audio amplifier with XLR audio inputs.
- using one audio amplifier with ¼ inch audio inputs.
- using 1 audio mixer or TV with RCA audio inputs

1.AUDIO OUTPUT 1 & 2 CONNECTIONS:

- Connect one end of the L/R (red & white) RCA cable to the red and white audio outputs labeled AUDIO OUTPUT 1 & 2 on the rear panel of the AKJ7809.
- Connect the other end of the L/R (red & white) RCA cable to the audio input on an audio mixer or TV.

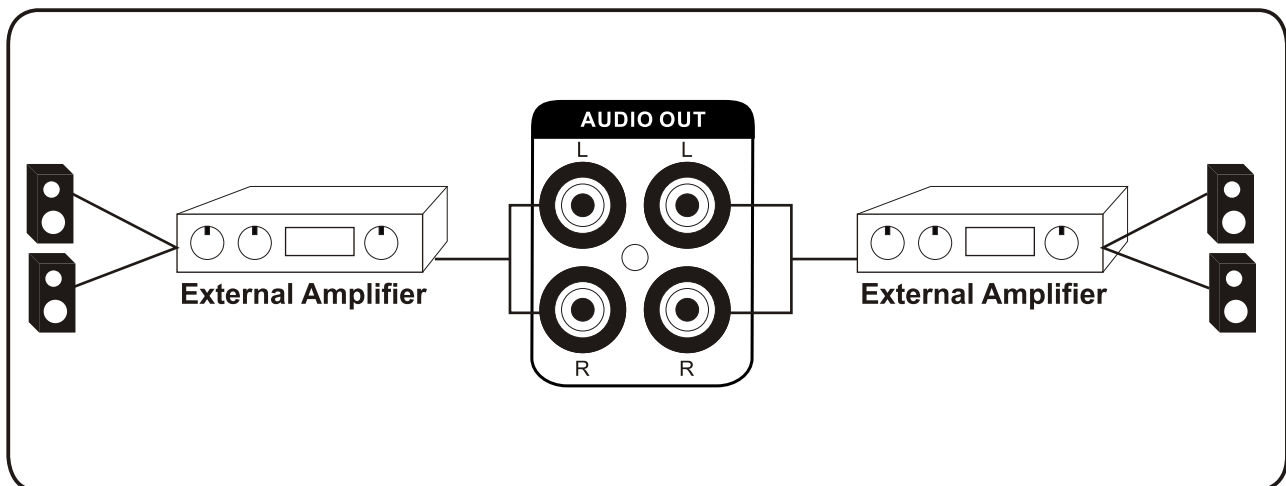
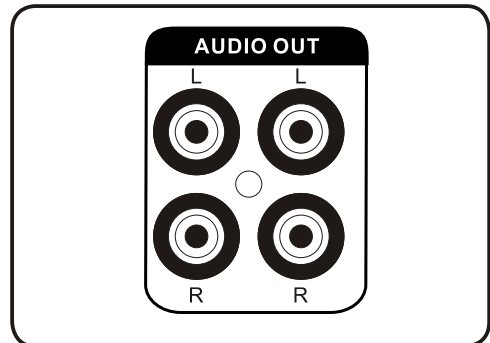

2.BALANCED AUDIO OUTPUT CONNECTIONS:

- Connect one end of the XLR cables to the left and right BALANCED AUDIO OUTPUT jacks on the AKJ7809.
- Connect one end of the XLR cables to the left and right AUDIO/LINE/AUX INPUT jacks on the external device.

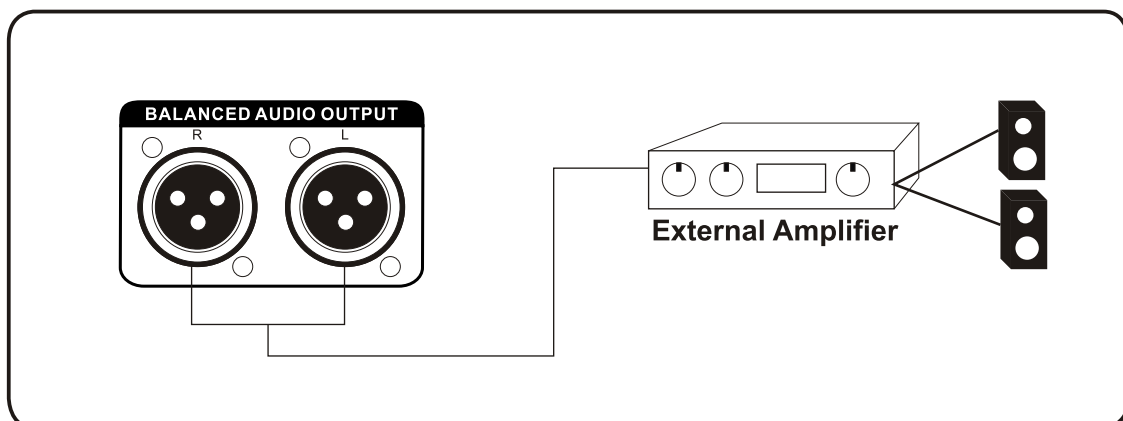

Basic Connections

3. ¼ INCH PRE-OUT CONNECTIONS:

- Connect one end of the ¼ inch audio cables to the left and right PRE-OUT jacks on the AKJ7809.
- Connect the other end of the ¼ inch audio cables to the left and right AUDIO/LINE/AUX INPUT jacks on the external device.

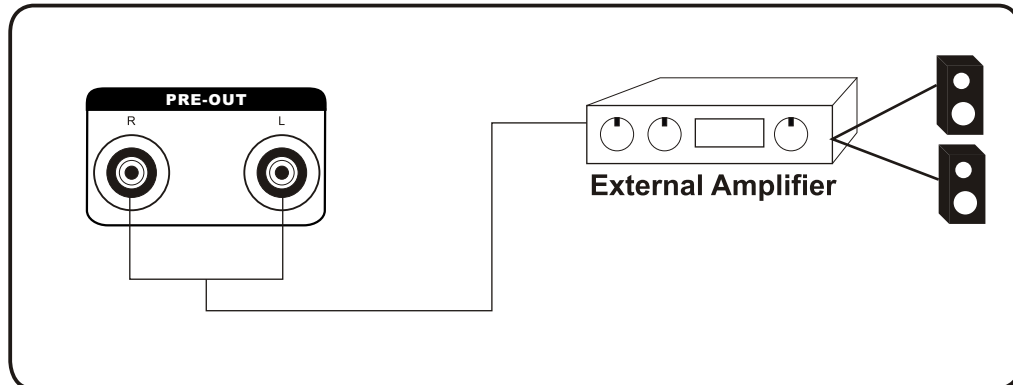

4. CONNECTING EFFECTS USING THE EFFECT INSERT:

1. Connect one end of the ¼ inch stereo audio cables to the GUITAR EFFECT, KEYBOARD EFFECT, or MIC EFFECT inserts on the rear panel of the AKJ7809.
2. Connect the other end of the ¼ inch stereo audio cables to the sound effect device.
3. By using the built-in EFFECT INSERT you can add external effects to vocals and/or guitar or keyboard or microphone without compromising the quality of the original signal.

DVD Output Connections

The effect insert is a break point in the input channel signal path, It allows the signal to be taken out from this AKJ7809, through an external equipment such as a Limiter, Compressor, Equalizer, Effector, and then back to the AKJ7809, the input jack can be used with ¼ inch phone jack, the signal will be send out through TIP of the ¼ inch phone jack and back to the AKJ7809 through RING of the ¼ inch phone jack.

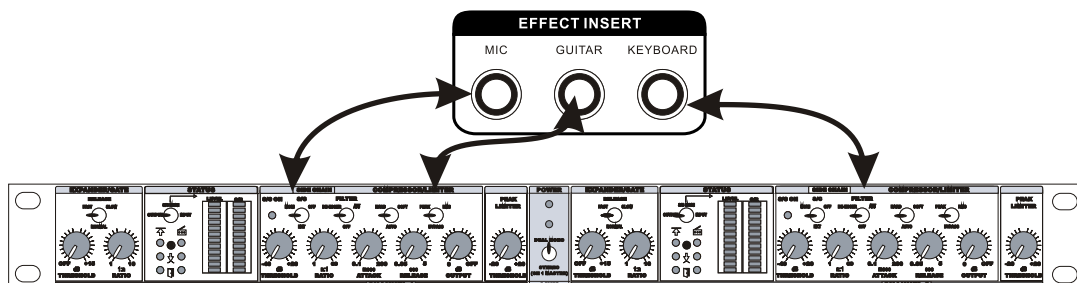

DVD Output Connections

DVD OUTPUT CONNECTIONS

1. Connecting to a Dolby Pro Logic amplifier

The AKJ7809 allows DVD audio output for 5.1 or 7.1 configurations.

With a 5.1 amplifier, you will need six RCA patch cables. Connect the plug from one side of each cable to the ML, CEN, SL, MR, SW and SR outputs on the AKJ7809. Connect the plug from the other side of each cable to the corresponding ML, CEN, SL, MR, SW and SR inputs on your 5.1 amplifier.

A 7.1 Pro Logic configuration requires 2 additional RCA cables to be connected from the FL and FR outputs of the AKJ7809 to your 7.1 Amplifier.

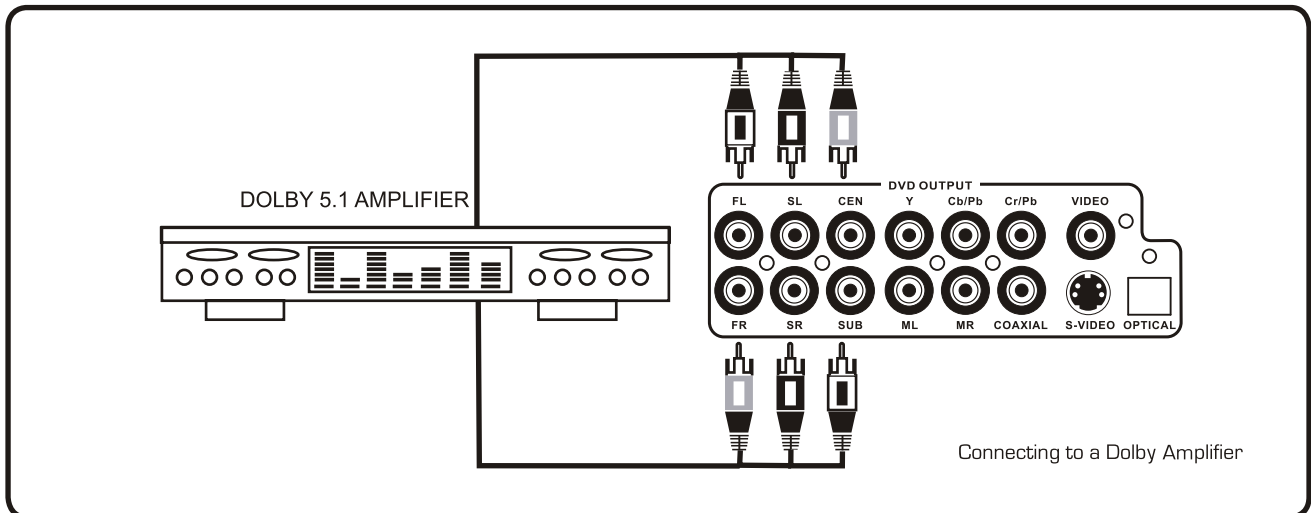

2. Connecting to a TV with component video

Using 3 appropriate component video cables (usually color coded red, blue and green), connect a set of plugs to the COMPONENT VIDEO OUT jacks (Y-U/Pb-V/Pr) on the AKJ7809 and plug the other set of plugs to the COMPONENT VIDEO IN jacks (Y-U/Pb-V/Pr) on your television. On some TVs, the component video input jacks may be labeled differently (i.e. Pr/Pb/Y or Cr/Cb/Y or R-Y/B-Y/Y etc.). You will need to press the MODE button on the remote control to toggle between YUV for Component Video, and S-Video. You can only use the MODE button when there is no disc inserted in the disc tray.

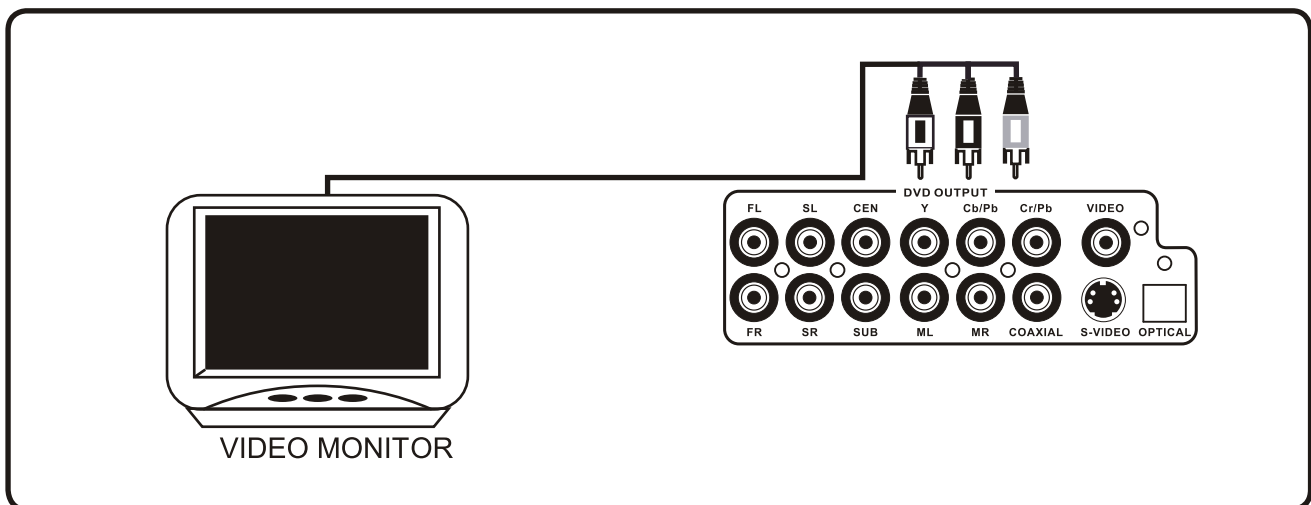

DVD Output Connections

3. Connecting to a DTS receiver/decoder

Using either a RCA-ended COAXIAL cable suited for digital audio use or an OPTICAL cable, connect one end to the appropriate jack on the AKJ7809 (COAXIAL or OPTICAL) and the other end to the appropriate jack (COAXIAL or OPTICAL). If you have both coaxial and optical inputs on your DTS decoder/receiver, it is recommended to use an optical connection as those cables eliminate the possibility of EMI (electromagnetic interference). If your DTS decoder/receiver has 5.1 or 7.1 channel RCA inputs, you can use the 5.1 or 7.1 channel output jacks on the AKJ7809.

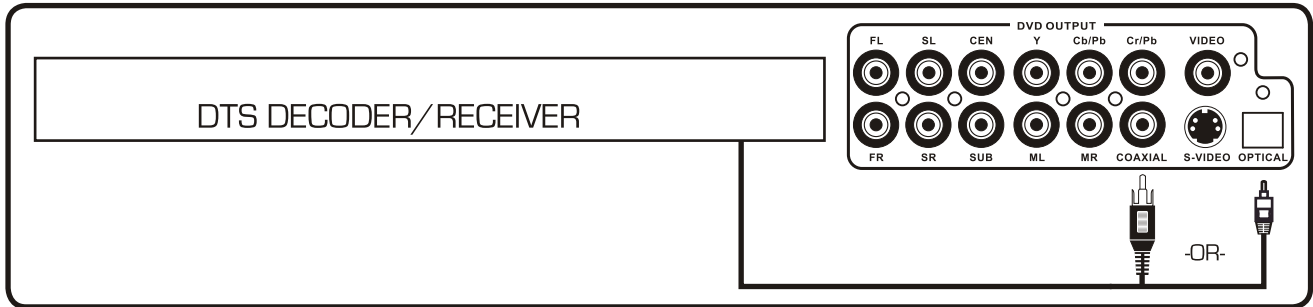

General Connections

AV input connections

What you will need

- 3 RCA-style A/V cable (included)
- 2 A/V output Device

1. Connect one end of the 3 RCA-style A/V cable to the A/V VIDEO/L/R input labeled AV1/AV2/AV3 on the front panel of the AKJ7809.
2. Connect the other end of the 3 RCA-style A/V cable to the A/V VIDEO/L/R output on an A/V output Device.

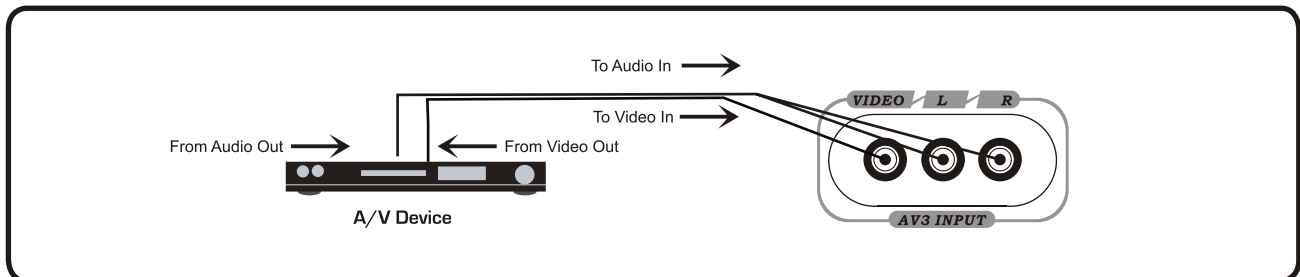

General Connections

Headphones connections

What you will need

- Headphones with a 1/4 inch connector at the other end of the cable (not included).
1. Connect the connector of the headphones to the 1/4 inch HEADPHONES output on the front panel of the AKJ7809.

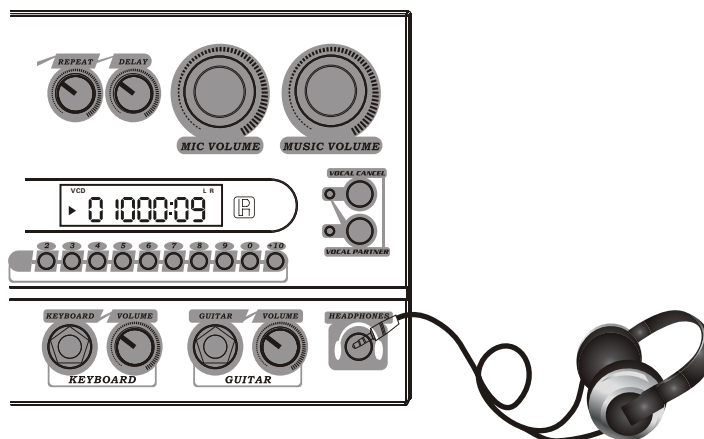

Microphone/instrument input connections

After completing your main system connections, it is time to get your microphones and instruments connected and ready for performing. Before you get started with your connections we recommend that you take the following tips into consideration:

- When connecting instruments, refrain from using low quality or worn cables as they can cause significant noise and loud pops, posing a threat to the system's speakers.
- Use caution when connecting a chain of multiple effects pedals, as the output voltage may change and possibly overload the AKJ7809 input channel.

The AKJ7809 has one guitar (1/4 inch), one keyboard (1/4 inch) and two microphone (1/4 inch/XLR) inputs.

1. To connect MICROPHONES via 1/4 inch mic cables, connect the XLR-end of the cable into the MICROPHONE until it locks into place and connect the 1/4 inch plug into either the MIC 1 or 2 jack on the AKJ7809.
2. To connect MICROPHONES via XLR mic cables, attach the XLR "female" end of the cable into the "male" three prong jack located at the base of your handheld MICROPHONE until it locks into place. Then connect the XLR "male" jack at the other end of the cable into either of the BALANCED MIC 1 or 2 inputs on the AKJ7809 rear panel. It should be obvious which sides of your XLR cable are male and female as there is only one possible connection.
3. To connect a GUITAR, connect a 1/4 inch instrument cable from the GUITAR's 1/4 inch output to the AKJ7809 1/4 inch GUITAR input.
4. To connect a KEYBOARD, connect a 1/4 inch instrument cable from the KEYBOARD's 1/4 inch output to the AKJ7809 1/4 inch KEYBOARD input.

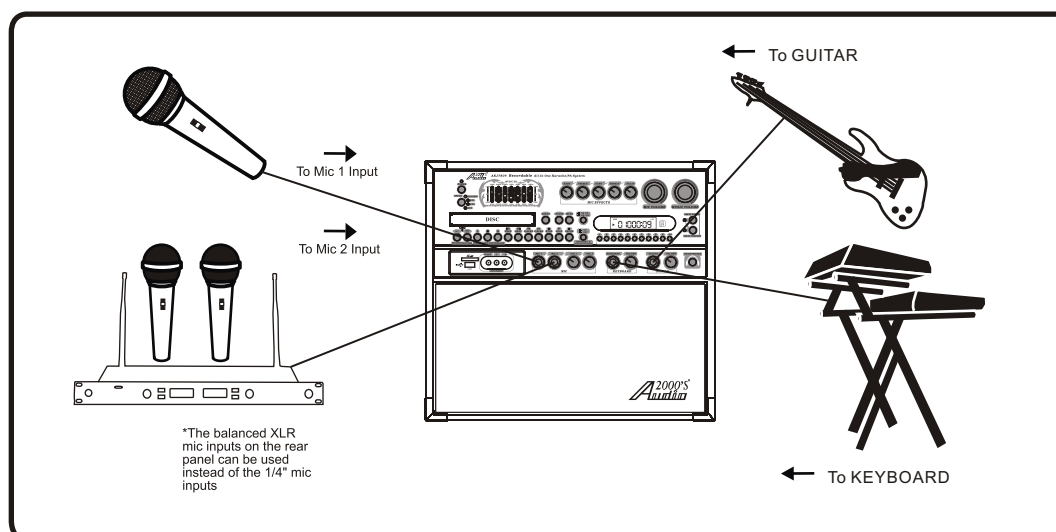

General Operations

Turning the AKJ7809 On, Off and to Standby

Press the power button on the AKJ7809 to turn the unit on or off.

Input Channels

The AKJ7809 has 4 available input channels:

- Disc/USB/SD: Turns on the AKJ7809's disc player for playing DVD, CD, CDG, and other discs.
- AV1/AV2/AV3: For playing a device that is connected to the AV1/AV2/AV3 RCA audio/video inputs on the front and rear panels.

Selecting an Input channel

1. Use the input select buttons on the remote control (DVD, AV1, AV2 and AV3) to directly select the desired input channel or use the SELECT button on the front panel to cycle through the input channels
2. Once the desired input channel is selected, playback can begin

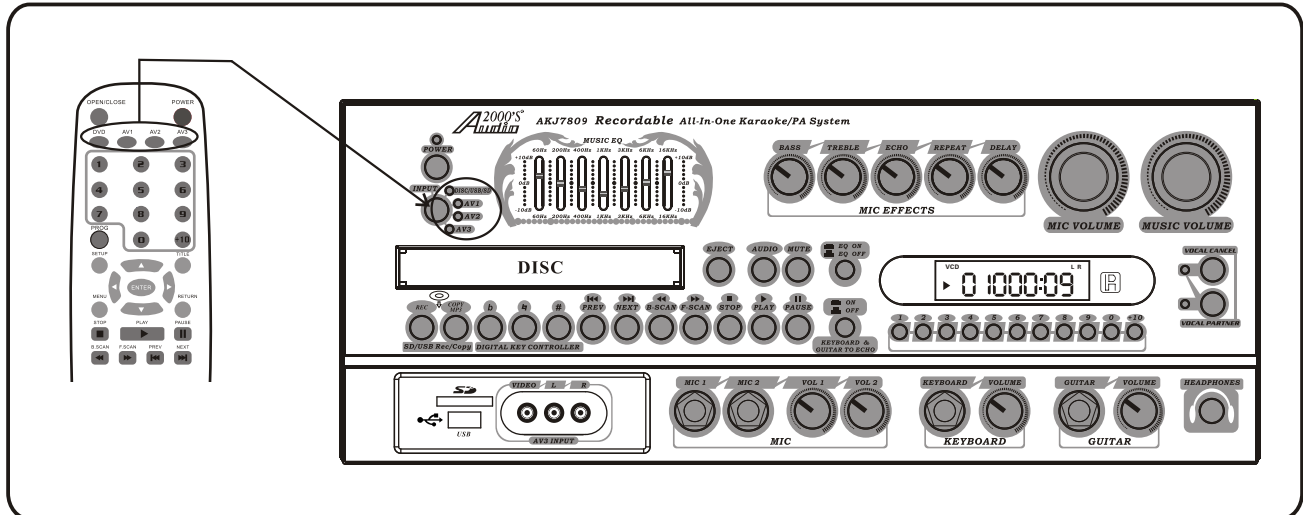

Adjusting the master Music Volume

The master Music Volume for the disc player, and AV input channels can be adjusted using either the front panel control or the remote control.

- **Front Panel:** Turn the MUSIC VOLUME control clockwise to raise the volume and counter-clockwise to lower the volume.

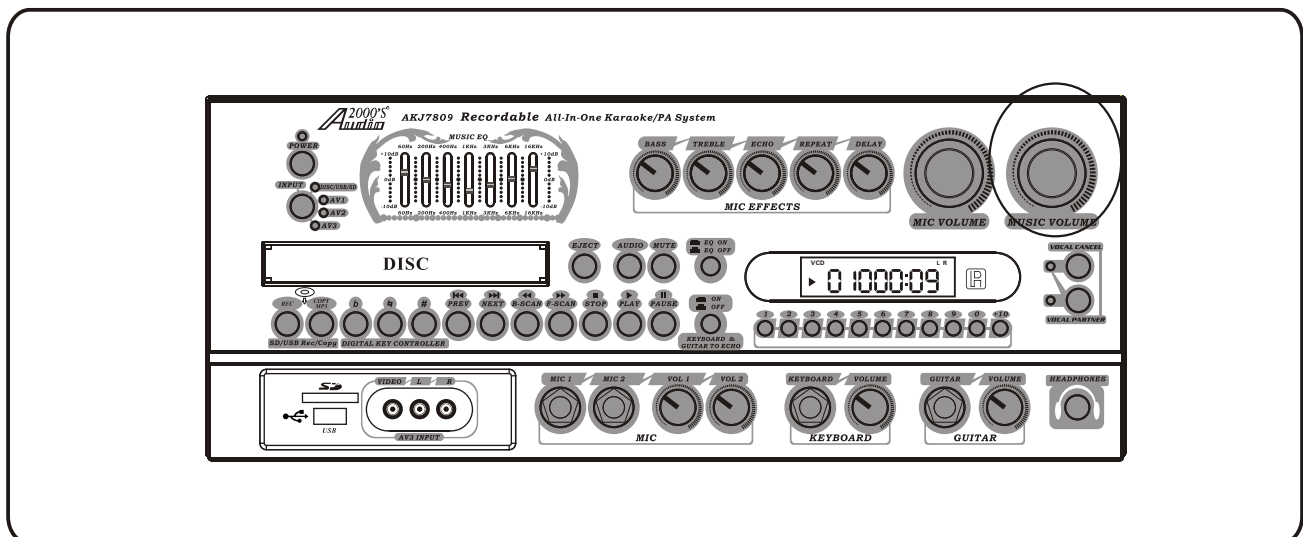

Adjusting the master Microphone volume

The master Microphone Volume can be adjusted using either the front panel control or the remote control

- **Front Panel:** Turn the MIC VOLUME control clockwise to raise the volume and counter-clockwise to lower the volume

General Operations

Adjusting the master MUSIC EQ

The master MUSIC EQ for the disc player, DISC/USB/SD/AV1/AV2/AV3 input channels can be adjusted using the front panel control

Front Panel

Turn the MUSIC EQ control slider up to raise the EQ for 10dB and down to lower the EQ for 10dB.

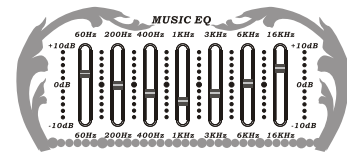

Changing the video mode (PAL / NTSC)

Use the P/N button on the remote control to switch between the regional PAL and NTSC video modes.

Operations (Disc Mode)

Access DISC mode by either pressing DVD on the remote control or by pressing the DISC/USB/SD button on the front panel until the display screen says disc.

Loading a disc

1. Press the OPEN/CLOSE button on the remote control or the EJECT button on the front panel of the AKJ7809 to open the disc tray
2. Insert a disc
3. Press the OPEN/CLOSE button on the remote control or the EJECT button on the front panel of the AKJ7809 to close the disc tray

Playing a disc

1. Load a disc
2. Press PLAY on the remote control or on the front panel

Stopping a disc

1. Press the STOP button on the remote control or front panel once to enter pause mode
2. Press the STOP button again to completely stop the disc

Pausing a disc

1. Press the PAUSE button on the remote control or front panel

Skipping tracks/chapters

1. Use the PREV and NEXT buttons on the remote control or front panel to skip tracks/chapters
2. Press the PREV button to skip to the previous track/chapter
3. Press the NEXT button to skip to the next track/chapter

Searching through a track/chapter

1. Use the B.SCAN and F.SCAN buttons on the remote control or front panel to search through tracks/chapters
2. Press the B.SCAN button to search backwards through the current track/chapter
3. Press the F.SCAN button to search forwards through the current track/chapter

Note: It will not work while playing CDG format disc

Subtitles

Some DVDs have subtitles available and some also include multiple languages. If you are using a DVD with subtitles available, simply press the SUBTITLE button on the remote control to cycle through the available subtitles

Viewing multiple angles

Some DVDs have multiple viewing angles available. Press the ANGLE button on the remote control to change the viewing angle and cycle through the available angles.

Slow-motion playback using the SLOW button

Use the SLOW button on the remote control to cycle between 4 slow-forward modes :

- SLOW 1/2 - Forwards at 1/2 the actual time
- SLOW 1/4 - Forwards at 1/4 the actual time
- SLOW 1/8 - Forwards at 1/8 the actual time
- SLOW 1/16 - Forwards at 1/16 the actual time .

Operations(Disc Mode)

Viewing one frame at a time using the STEP button

- 1.Press the STEP button on the remote control to enter Step mode
- 2.Every time the STEP button is pressed, when in Step mode, the movie will advance one frame
- 3.Press the PLAY button on the remote control or front panel to exit Step mode and return to normal playback

Selecting repeat options

Press the REPEAT button on the remote control to cycle through the available repeat modes:

- 1.Track - Repeats the current track
- 2.Chapter - Repeats the current chapter on a DVD
- 3.Title - Repeats the current title on a DVD
- 4.All - Repeats the entire disc once it has played through
- 5.Repeat off- Turns off Repeat.

Creating a loop using the A-B button

The A-B feature allows you to loop a certain part of a disc.

While the disc is playing:

- 1.Press the A-B button once at the desired starting point for the loop
- 2.Press it again at the desired ending point for the loop
- 3.Press it a third time to end the loop and return to normal playback

Note:It will not work while playing CDG format disc

Canceling vocals using the L/R button

Multiplex CDG discs are designed to have vocals on one side and music on the other. The L/R button allows you to play only one of these sides and cancel out the other in order to have music-only or vocals-only.Press the L/R button to cycle through the available settings:

- Mono Left - Left channel only (no vocals)
- Mono Right - Right channel only (no music)
- Mix-Mono - Virtual stereo
- Stereo - Left and Right in true stereo

Note: This feature is only for use with specifically Multiplex formatted CDG discs.

Zooming in and out

The AKJ7809 lets you zoom in and out on the video screen.

Press the ZOOM button on the remote control to cycle through the available zoom settings.

Zoom in

- 2X - Zooms in 2X the original size
- 3X - Zooms in 3X the original size
- 4X - Zooms in 4X the original size

Note:when you try to play MPG and JPG file(include the MPG and JPG file on DISC,USB,SD):

1. Press the ZOOM button on the remote control to enter ZOOM mode;
2. Use the F.SCAN and B.SCAN button to control zoom in and zoom out function;

Jumping to specific time on a disc

Press the TIME button on the remote control to cycle through the available jump-to options:
CD/CDG disc

- Disc Go To (CD/CDG only) - Jump to a specific time on the current disc
- Track Go To (CD/CDG only) - Jump to a specific time on the current track
- Select Track (CD/CDG only) - Jump directly to a specific track

Note:It will not work while playing CDG format disc

Example:

Jumping to 1:35 in the current track

- 1.Press the TIME button until "TRACK GO TO - - | - -" appears on the TV screen
- 2.Press 0, 1, 3, 5
- 3.Playback will begin at 1:35 on the current track

DVD disc

Note: Not all discs have multiple titles. A title refers to the different sections including the movie, special features,etc.

- Title / Chapter (DVD only) - Select the title and then jump to a chapter within that title
- Title / Time (DVD only) - Select a title and then jump to a specific time within that title
- Chapter / Time (DVD only) - Select a chapter and then jump to a specific time within that chapter

Operations(Disc Mode)

Example:

Selecting a Title and Chapter

Jumping to title 2 and chapter 2

- 1.Press the TIME button until TITLE “ __ / __ CHAPTER __ / __ ” appears on the top of the TV screen
- 2.Press 2 on the number pad to select Title 1. Now chapter will be highlighted
- 3.Press 2 on the number pad to select Chapter 2
- 4.Playback will begin at that on Title 2 and Chapter 2

Viewing and setting the On Screen Display (OSD)

Press the OSD button on the remote control to cycle through the available OSD viewing options.

CD/CDG discs

- Single Remain - The time remaining on the current track
- Single Elapsed - The time elapsed on the current track
- Total Remain - The time remaining on the entire disc
- Total Elapsed - The time elapsed on the entire disc
- Display Off - Turns the OSD off

DVD discs

- Title Remain - The time remaining on the current title
- Title Elapsed - The time elapsed on the current title
- Chapter Remain - The time remaining on current chapter
- Chapter Elapsed - The time elapsed on the entire chapter

Turning on the last memory function:

- 1.Press SETUP on the remote control. The General Setup page will show.
- 2.Use the down arrow button on the remote control to scroll down to Last Memory
- 3.If Last Memory is set to off, press enter when Last Memory is highlighted and press up so that On is highlighted
- 4.Press ENTER on the remote control to confirm the selection
- 5.Press SETUP again on the remote control to close the Setup menu

PROG (Program) Operations

1. CD, CDG and VCD Playback:

- Insert a CD, CD-G, or VCD in the disc tray and press the PROG button to enter the program mode. The TV monitor display will show the program menu as in Photo J. In the program menu, the track numbers of the songs on a disc can be entered to the program menu in a desired order, up to 20 tracks. The same track on a disc can be entered multiple times. Use the directional buttons (< > ^ ^) to go to the track location in the program menu to make any correction or delete the track from the program menu by pressing the CLEAR button.



PHOTO (L)



PHOTO (J)

- Upon completing the program menu setup, use the directional buttons (< > ^ ^) to go to the PLAY indicator in the program menu and press the ENTER button to start the playback according to the track order set up in the program menu. The PROG indicator on the display panel will be on (as shown in Photo K) when the programmed playback is in progress. Press the PLAY button on the remote control twice to stop the programmed playback.

Operations(Disc Mode)

2. DVD Playback

● Insert a DVD in the disc tray and press the PROG button to enter the program mode. The TV monitor display will show the program menu as in Photo L. In the program menu, enter the title number under the column "T" and enter the chapter number under the column "C". Up to 20 songs on a DVD can be entered to the program menu in a desired order. The same song on a DVD can be entered multiple times. Use the directional buttons (< > ^ ^) to go to the song location in the program menu to make any correction or delete the song from the program menu by pressing the CLEAR button.



PHOTO (K)



PHOTO (M)

● Upon completing the program menu setup, use the directional buttons (< > ^ ^) to go to the PLAY indicator in the program menu and press the ENTER button to start the playback according to the song order set up in the program menu. The PROG indicator on the display panel will be on (as shown in Photo M) when the programmed playback is in progress. Press the PLAY button on the remote control twice to stop the programmed playback.

NOTE: The PROG operations are not applicable to MP3 or MP4 discs.

Operations (MP3 and AVI / DivX)

When playing MP3 and DivX files, the AKJ7809 must be connected to a TV in order to see and navigate through the file menu. Use the arrow buttons on the remote control to navigate through the file menu and the ENTER button to select a file to play.

To play a file

1. Use the arrow buttons on the remote control to scroll to the desired file
2. Press ENTER on the remote control to begin playing the file
3. The file will begin playing

or

1. Use the number buttons on the remote control and enter the file number
2. Press ENTER
3. The file will begin playing

Direct track access:

When playing MP3 or AVI/DivX files, to skip to the desired track directly using the number buttons, see the following operations section for detailed instruction:

1. For example: to go directly to track 142 of MP3/AVI/DivX: you would press 1 and 4 and 2, then press ENTER button on remote control for playing your desired track.
2. For example: to go directly to track 36 of MP3/AVI/DivX, you would press 0 and 3 and 6, then press ENTER button on remote control for playing your desired track.

Note: The desired track you selected must be less than the total tracks on the MP3/AVI/DivX;

Repeat options

There are six repeat options when playing Divx Files. Use the REPEAT button on the remote control to cycle through these repeat options:

- Random - Plays songs randomly from the entire disc
- Single - Playback stops after a single track finishes playing
- Repeat One - Repeats the current song continuously
- Repeat Folder - Repeats the entire folder after it has played through
- Folder - Playback stops after all of the songs in the current folder have played
- Shuffle - Plays songs randomly within the current folder

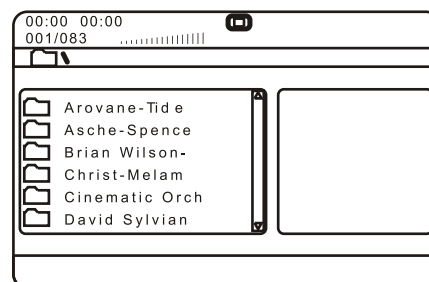
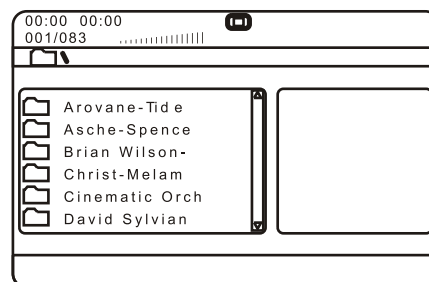

USB and SD Card Operations (Disc Mode)

USB and SD CARD operations (Disc Mode)

Use the DISC select button on the front panel or DVD select button on the remote control to directly select the desired DISC MODE, do not put DISC into the tray, when the graphic display on the front panel displays "NO DISC", then insert USB and SD CARD to the USB and SD CARD jacks, then begin to load the media sources from USB or SD CARD.

1. Using the USB input

- Plug a USB thumb drive into the USB Input.
- Use the directional buttons to select videos, music, or images. Press the Enter button to play a selected video, music, or image.

Note: The unit will play your VCD, WMA, AVI, MP4, DAT, MPG and JPG files. The different file types must be separated into folders for the unit to read them.

2. Using the SD card slot

- Plug an SD card into the SD memory card slot.
- Use the directional buttons to select videos, music, or images. Press the Enter button to play a selected video, music, or image.

Note: The unit will play your VCD, WMA, AVI, MP4, DAT, MPG and JPG files. The different file types must be separated into folders for the unit to read them.

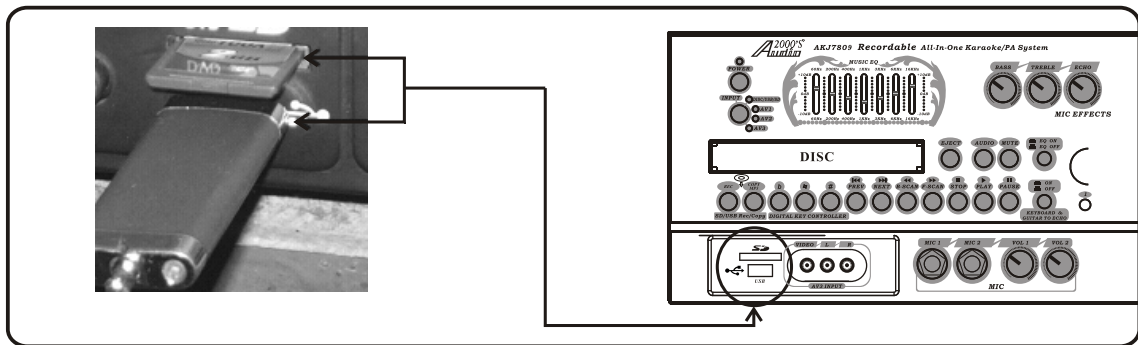

USB and SD Card REC / COPY Operations

1. REC (Record) Operations:

- With a compact disk (in CD, CDG, MP3, MP4, DIVX, or VCD format) in the disc tray, insert a USB device or an SD card and press this REC button to start recording. Right before the recording process, the AKJ7809 will search for the "MUSIC" folder. A "MUSIC" folder will be created if it does not exist in the USB device or SD card. During the recording process, the microphone input will be automatically mixed with the background music from the compact disc and be recorded to the USB device or SD card in the MP3 format. In the meantime, the percentage (0-100%) of the recorded portion of a song will be displayed on the TV or monitor screen as shown in Photo A.
- The recorded content will be recorded and numbered consecutively in the "MUSIC" folder. Each recorded content is named with the track number on the disk as shown in Photo C. If a repeated track number is used, the track number will be followed by an alphabet. For example, if track 5 on one disk is recorded, the recorded content will be named "TRACK5". When another track 5 on another disk is recorded, it will be named "TRACK5A". Next recorded track 5 on another disk will be named "TRACK5B".
- After the recording is completed, press the DVD button on the remote control to enter the display as shown in Photo B. Select USB or CARD (SD Card) and press the ENTER button on the remote control to enter the playback mode.
- In the playback mode, use the directional buttons (< > ^ ^) to go to the "MUSIC" folder and press the ENTER button to open the "MUSIC" folder as shown in Photo C. Go to the desired recorded song to start playback. (The order of the recorded songs in the "MUSIC" folder is based on the times that the songs were recorded.)

NOTE: This recording function does NOT support any DVD disc.

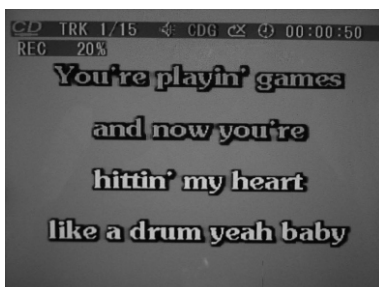

PHOTO (A)



PHOTO (B)



PHOTO (C)

USB and SD Card REC Operations

2. COPY Operations (from CD or CDG to USB or SD Card):

- With a CD or CDG in the disc tray, insert a USB device or an SD card and press this COPY button to enter the downloading mode. At the downloading mode, the TV/monitor display is as shown in Photo D.
- Use the directional buttons (< > ^ ^) to go to "TRACKS" and press the ENTER button to open the display as shown in Photo E. After selecting the desired track number in Photo E, move the cursor to START and press the ENTER button to start downloading as shown in Photo F. Right before the downloading process, the AKJ7809 will search for the "UNKNO" folder. A "UNKNO" folder will be created if it does not exist in the USB device or SD card. The song in the CD or CDG will be converted to MP3 and downloaded to the "UNKNO" folder.

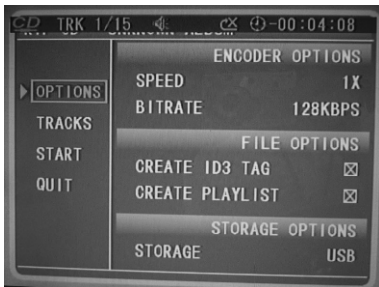

PHOTO (D)

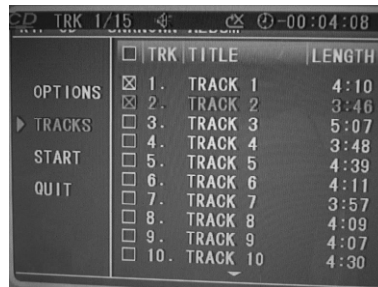

PHOTO (E)

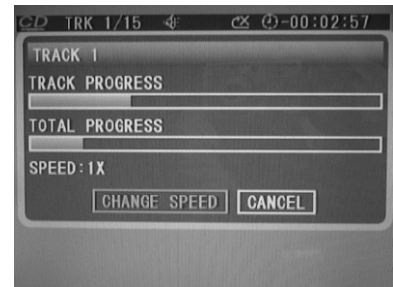

PHOTO (F)

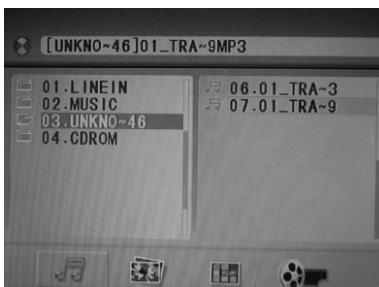

PHOTO (G)

- After the MP3 downloading is completed, press the DVD button on the remote control to enter the display as shown in Photo B. Select USB or CARD (SD Card) and press the ENTER button on the remote control to enter the playback mode. In the playback mode, use the directional buttons (< > ^ ^) to go to the "UNKNO" folder and press the ENTER button to open the "UNKNO" folder as shown in Photo G. Go to the desired song to start playback. (The order of the downloaded songs in the "UNKNO" folder is based on the times that the songs were downloaded.)

NOTE: This downloading function supports only CD and CDG discs.

3. COPY Operations (from MP3 to USB or SD Card):

- With a MP3 disc in the disc tray, insert a USB device or an SD card and press this COPY button to start the copying. During the copying process, the percentage (0-100%) of the copied portion of the file will be displayed on the TV or monitor screen as shown in Photo H. Right before the copying process, the AKJ7809 will search for the "CDROM" folder. A "CDROM" folder will be created if it does not exist in the USB device or SD card. The file in the Mp3 disc will be copied to the "CDROM" folder.

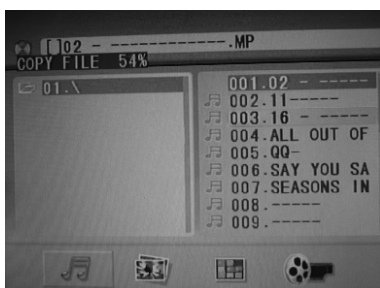

Photo (H)



Photo (I)

- After the MP3 copying is completed, press the DVD button on the remote control to enter the display as shown in Photo B. Select USB or CARD (SD Card) and press the ENTER button on the remote control to enter the playback mode. In the playback mode, use the directional buttons (< > ^ ^) to go to the "CDROM" folder and press the ENTER button to open the "CDROM" folder as shown in Photo I. Go to the desired file to start playback. (The order of the copied files in the "CDROM" folder is based on the times that the files were copied.)

NOTE: This copying function supports only MP3 discs.

Microphone Operations

Turning on the Microphones

Each ADM1064B microphone has an On/Off switch.

1. Flip the microphone's On/Off switch UP to turn the microphone ON.
2. Flip the microphone's On/Off switch DOWN to turn the microphone OFF.

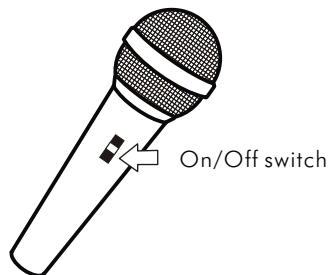

Adjusting the master Microphone volume

The master Microphone Volume can be adjusted using either the front panel control or the remote control

Front Panel

Turn the MIC VOLUME control clockwise to raise the volume and counter-clockwise to lower the volume

Adjusting the individual Microphone volume controls

1. Each microphone channel has its own volume control located on the front panel of the AKJ7809. Each one can be adjusted separately, providing a great sounding vocal mix.
2. Turn the MIC 1 VOL and/or MIC 2 VOL control clockwise to raise the volume and counter-clockwise to lower the volume.

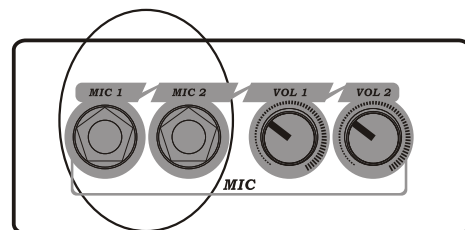

Adjusting the Microphone tone

The AKJ7809 has microphone tone controls on the front panel, allowing you to create clearer and more professional vocals.

- MIC TREBLE - Try increasing the TREBLE tone if the sound is too bassy or muddy and decreasing it if it is too hi-pitched or if there is a lot of feedback.
- MIC BASS - Try increasing the BASS if the sound is not deep enough and decreasing it if the sound is too muddy or muffled.

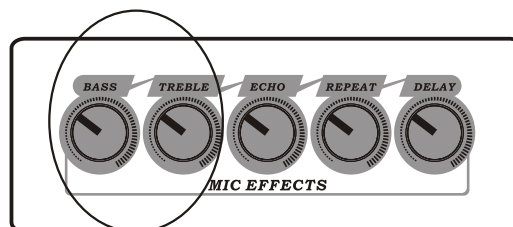

Note

Note: There is no correct tone setting. There are many factors that affect the tone including the singer's own vocal tone, the room, etc. Adjust the TREBLE and BASS controls until you are pleased with the sound.

Microphone Operations

Using digital Echo

Digital Echo gives vocals a more professional, studio-produced sound and is a great way to make any singer sound like a seasoned professional. There are three controls, located on the front panel, for adjusting the Echo effect:

- **ECHO** - This controls the amount of Echo effect that will be heard. Turn clockwise to increase the amount of echo and counter-clockwise to decrease it. Turn the ECHO control fully counter-clockwise to turn the echo effect off.
- **REPEAT** - Use this control to adjust the REPEAT setting of the ECHO effect. As REPEAT adjusts the total number of echo intervals prior to fade-out, the more REPEAT that is applied, the more ECHO intervals will occur prior to fade-out. Turn control clockwise to INCREASE and counter-clockwise to DECREASE level.
- **DELAY** - This control adjusts the amount of time between each echo repeat. Turn clockwise to make the time shorter and counter-clockwise to make the time longer

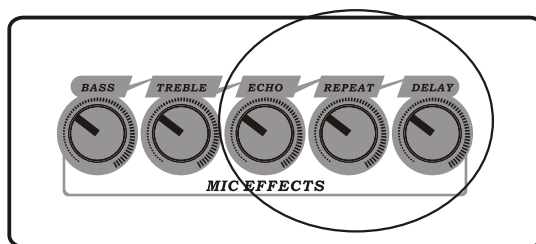

Adjusting the KEYBOARD volume

1. The master KEYBOARD Volume can be adjusted using the front panel control
2. Turn the KEYBOARD VOLUME control clockwise to raise the volume and counter-clockwise to lower the volume

Adjusting the GUITAR volume

1. The master GUITAR Volume can be adjusted using the front panel control
2. Turn the GUITAR VOLUME control clockwise to raise the volume and counter-clockwise to lower the volume

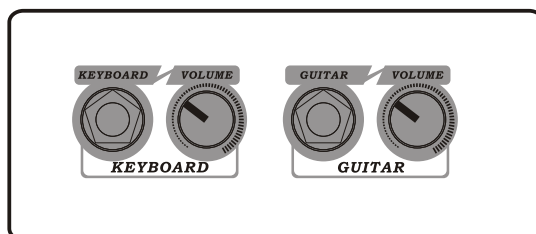

Note

NOTE: KEYBOARD & GUITAR TO ECHO ON/OFF button - This button is used to turn on or turn off the connection between the Keyboard / guitar inputs and the digital ECHO circuitry. Depress this button to activate the digital ECHO. Release this button to the UP position to disconnect the digital ECHO.

Descriptions and Functions

Front panel

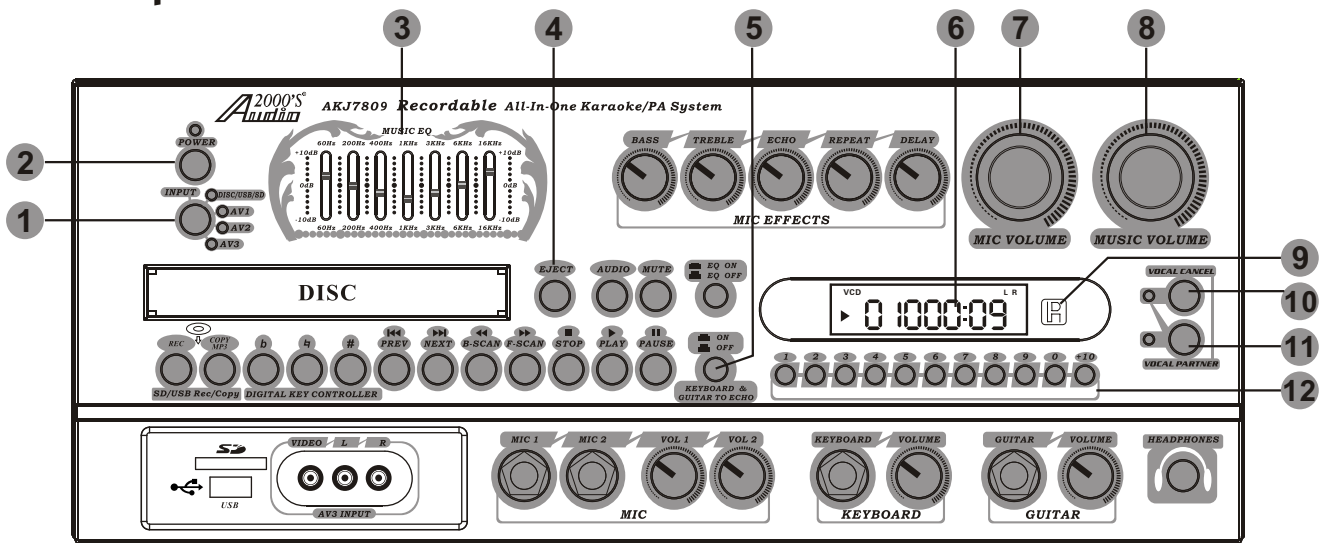

- 1.INPUT** - This button toggles through all the INPUT channels (Disc/USB/SD, AV 1/2/3) for available INPUT SOURCES.
- 2.POWER/STANDBY** - This button is used to turn the AKJ7809 'ON'/ 'OFF' or place it in STANDBY mode.
Note: When in STANDBY mode, the AKJ7809 is not completely powered down and still contains residual power. This button will not turn the AKJ7809 on if the MAIN POWER switch on the rear panel is switched off. To completely turn the power off, use the MAIN POWER switch on the rear panel of the AKJ7809.
- 3.MUSIC EQ** - This GRAPHIC EQ is used to BOOST and/or CUT particular frequencies from SOURCE MUSIC output. Each slide fader processes a particular frequency range indicated by the number above it. Frequencies from 30Hz - 120Hz constitute the very low to low range. Frequencies from 120Hz to 1KHz are the mid-range and frequencies from 1KHz to 16KHz make up the high to very high range. To adjust, slide the fader up to boost the frequency presence or down to cut the frequency.
- 4.EJECT** button - This button is used to OPEN/CLOSE the DISC tray.
- 5.KEYBOARD & GUITAR TO ECHO ON/OFF** button - This button is used to turn on or turn off the connection between the Keyboard / guitar inputs and the digital ECHO circuitry. Depress this button to activate the digital ECHO. Release this button to the UP position to disconnect the digital ECHO.
- 6.GRAPHIC DISPLAY** - This panel displays all graphical information regarding system operations, settings and performance.
- 7.MIC VOLUME** control - This control increases/decreases the MIC VOLUME level. Turn clockwise to increase MIC VOLUME and counter-clockwise to decrease the MIC VOLUME.
- 8.MUSIC VOLUME** control - This control increases/decreases the MUSIC VOLUME level. Turn clockwise to increase MUSIC VOLUME and counter-clockwise to decrease the MUSIC VOLUME.
- 9.REMOTE SENSOR** - This sensor receives infrared signals transmitted by the REMOTE CONTROL transmitter.
Note: Obstacles located between the remote control and remote sensor should be avoided as they can prevent signal recognition
- 10.VOCAL CANCEL** button - This feature is used to remove the lead vocal sound track signal on a multiplex format CDG, VCD, or DVD disc. In order for this feature to work, the disc must be multiplex formatted. Press this button once to remove the lead vocal singer sound track signal. Press this button again and the lead vocal sound track signal will be added back into the music.
Note: This feature does not work with a standard or non-multiplex format disc. This feature is designed to work with multiplex discs only.
- 11. VOCAL PARTNER** button - This feature is used to remove the lead vocal sound track signal only when the microphone signal is present (while you are singing to the microphone). When the microphone signal is not present (after you stop singing to the microphone), the lead vocal sound track signal will be added back to the music. In order for this feature to work, the disc must be multiplex formatted. Press this button once to activate VOCAL PARTNER. Press this button again to deactivate VOCAL PARTNER.
Note: Like the VOCAL CANCEL, this feature does not work with a standard or non-multiplex format disc. This feature is designed to work with multiplex discs only.
- 12.DIRECT TRACK ACCESS** buttons - These buttons are used for DIRECT TRACK selection. Use the +10 button for all the tracks higher than 10. For example, press +10 and 6 to go directly to track 16, and press +10, +10, and 3 to go directly to track 23.
Note: When playing AVI/DivX files, to skip to the desired track directly using the number buttons, refer to the Direct track access for AVI/DivX operations section of this manual;

Descriptions and Functions

Front panel

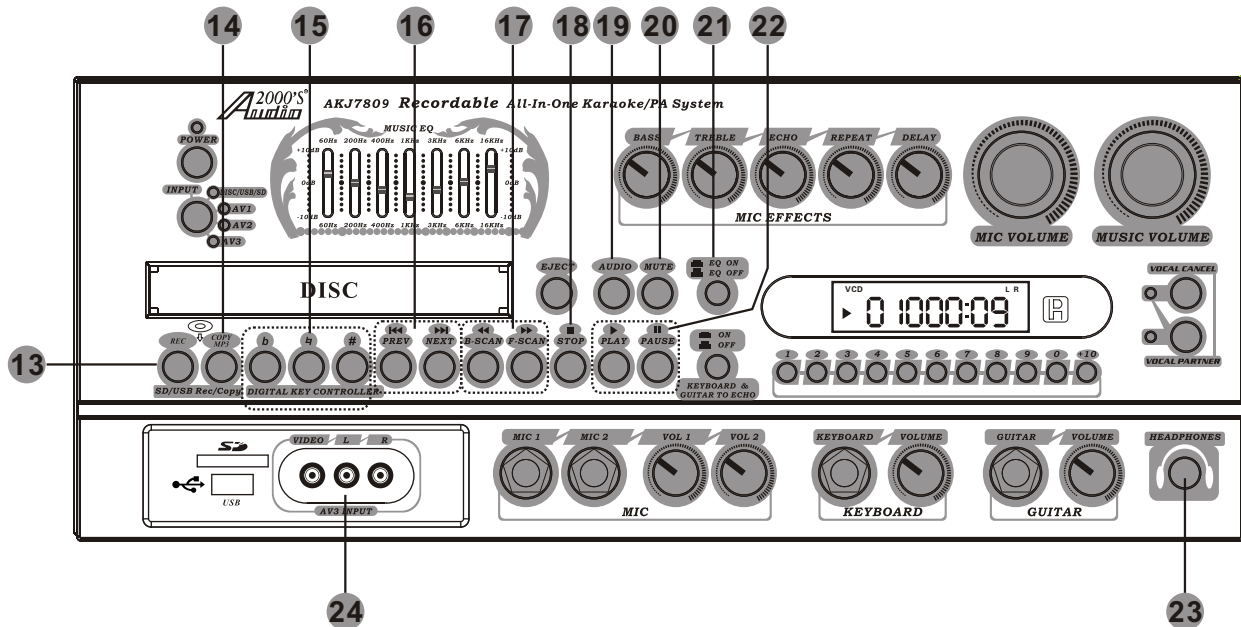

13.REC button - Please refer to page 16 for the details.

14.MP3 COPY button - Please refer to page 17 for the details.

15.DIGITAL KEY CONTROL buttons - These buttons direct the DIGITAL KEY CONTROLLER to either raise, lower or reset the musical key of audio from the disc player.

- # - Raises the musical key a half-step each time it is pressed.
- [square] - Resets the musical key to its original key.
- b - Lowers the musical key a half-step each time it is pressed.

NOTE:Key controller will not work on playing AV1/AV2/AV3.

16.Prev and Next buttons - Skip tracks when in DISC mode .jumps to the previous track and skips ahead to the next track.

17.B-Scan and F-Scan buttons - Scans through a track when in DISC mode.B-Scan scans backwards through the current track and F-Scan scans forwards through the current track.

18.Stop button - Stops disc playback in standby mode when pressed once and completely stops disc playback when pressed twice.

19.Audio button - Cycle through caption languages on a disc with multiple caption languages available.

20.Mute button - Mutes the sound from Disc/USB/SD,AV1 ,AV2and AV3 input channels.

21.EQ ON/OFF switch - This switch is used to turn the 7-band Graphic Equalizer ON and OFF. Press the EQ switch in to activate the equalizer. In the out position, the equalizer is bypassed.

22.PLAY/PAUSE button - Plays a disc that is stopped or paused .

23.HEADPHONES jack- This jack is used to connect HEADPHONES equipped with a 1/4inch plug.

24.AV3 INPUT jacks - These jacks are for connecting AUDIO/VIDEO OUTPUT from an external AV SOURCE. Connect RCA-style AV cables from these jacks to the AV OUTPUT jacks on your external AV device.

Descriptions and Functions

Front panel

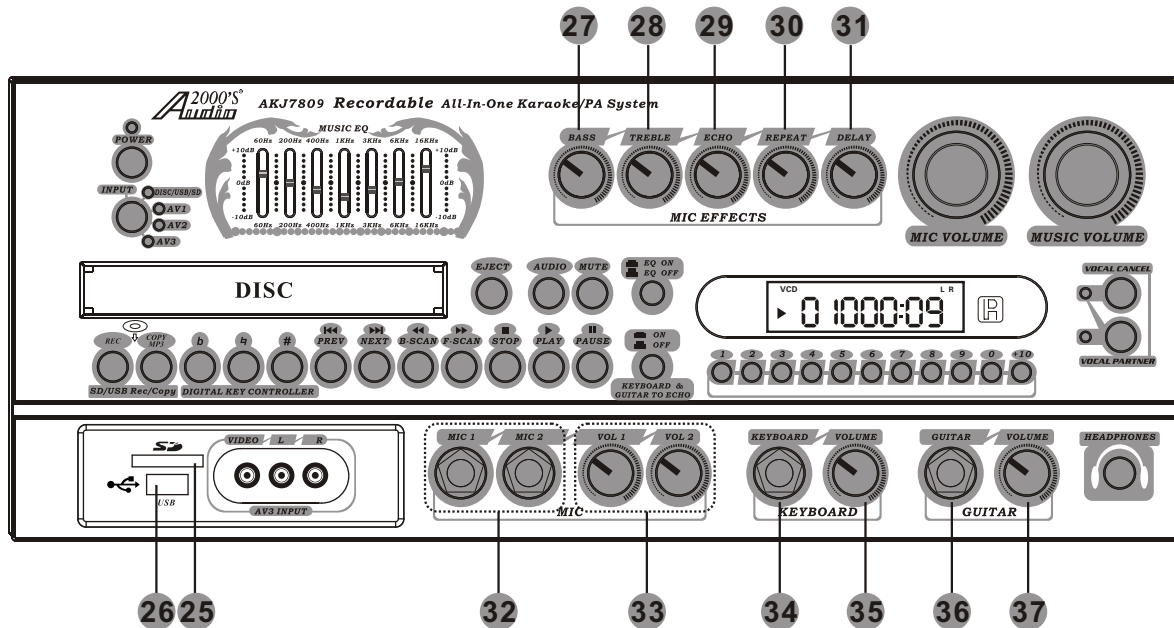

- 25. SD Memory Card - Slot** The SD Memory Card Slot accepts SD memory card formats. Media stored on a loaded memory card can be played.
- 26. USB Input** - Use the USB Input to connect a USB Thumb Drive to the unit. Media stored on the USB Thumb Drive can be played.
- 27. MIC BASS** - This control increases/decreases the amount of LOW frequency response applied to the MASTER VOLUME output.
- 28. MIC TREBLE** - This control increases/decreases the amount of HI frequency response applied to the MASTER VOLUME output.
- 29. MIC ECHO** - This control adjusts the level of ECHO applied to the MIC channels. Turn control clockwise to INCREASE and counter-clockwise to DECREASE the level of ECHO.
- 30. MIC REPEAT** - Use this control to adjust the REPEAT setting of the ECHO effect. As REPEAT adjusts the total number of echo intervals prior to fade-out, the more REPEAT that is applied, the more ECHO intervals will occur prior to fade-out. Turn control clockwise to INCREASE and counter-clockwise to DECREASE level.
- 31. MIC DELAY** - Use this control to adjust the DELAY setting of the ECHO effect. As DELAY adjusts the total begin-to-end length of each echo interval, the more DELAY that is applied, the longer each ECHO interval will take to complete. Turn control clockwise to INCREASE and counter-clockwise to DECREASE level.
- 32. MIC INPUTS 1, 2** - These inputs are for connecting MICROPHONES with a ¼ inch (6.3mm) plug.
- 33. MIC 1 / 2 VOLUME** - These controls adjust the VOLUME levels of MIC channels individually. Turn controls clockwise to INCREASE and counter-clockwise to DECREASE.
- 34. KEYBOARD INPUT** - This input is used to connect a KEYBOARD device via a ¼ inch instrument cable.
- 35. KEYBOARD VOLUME** - This control is used to set the VOLUME level for a KEYBOARD connected to the KEYBOARD INPUT JACK.
- 36. GUITAR INPUT** - This input is used to connect a GUITAR via a ¼ inch instrument cable.
- 37. GUITAR VOLUME** - This control is used to set the VOLUME level for a GUITAR connected to the GUITAR INPUT.

Descriptions and Functions

Rear panel

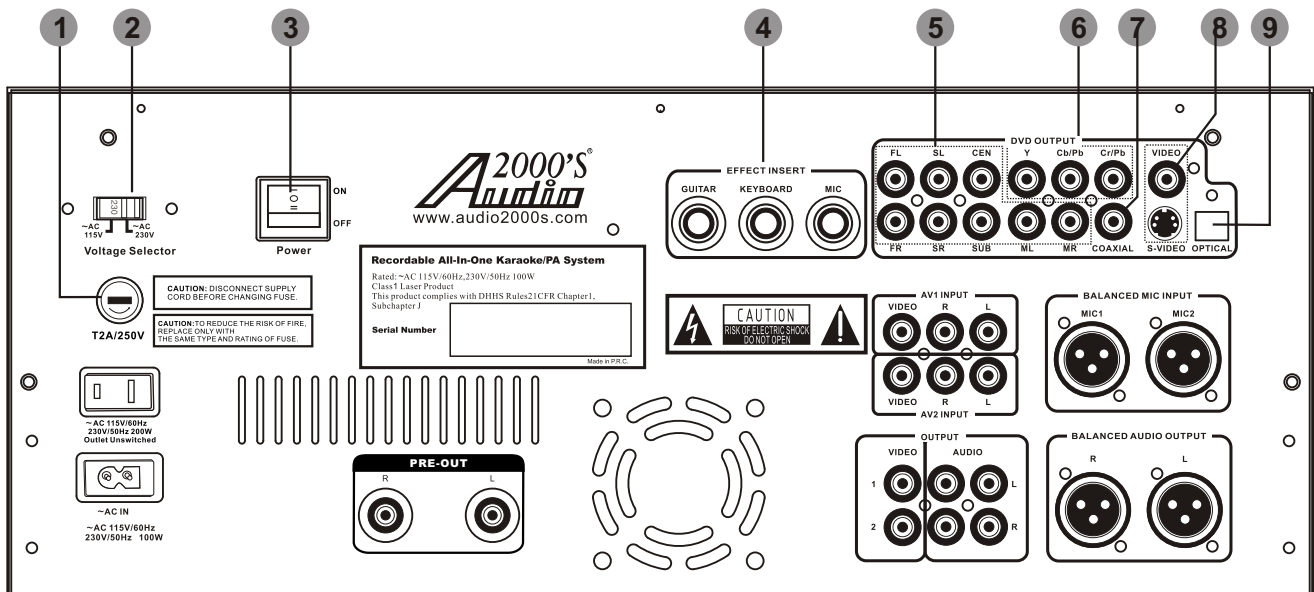

1.FUSE TERMINAL - This terminal houses the AKJ7809 main system FUSE.

2.VOLTAGE SELECTOR - This selector toggles between 110-120V and 220-240V power settings. Please make sure this toggle is set to the correct position, matching the receiving AC outlet's power supply before plugging it in and operating it. Not doing so may cause severe damage to the unit and void your product warranty.

3.MAIN POWER switch- This switch can be set to ON or OFF position as follows:

- ON - to turn on the AKJ7809 power.
- OFF - to turn off the AKJ7809 power.

Note: The red POWER /STANDBY button on the front panel will not turn the AKJ7809 on if the MAIN POWER switch is switched OFF.

4.EFFECTS INSERT jacks - The effects inserts allows you to add external effects to the audio signal without compromising the original signal. Use the MIC IN/OUT when adding effects to the vocal signal ,use the KEYBOARD IN/OUT when adding effects to the Music and use the GUITAR IN/OUT when adding effects to the music.

5. 5.1 CHANNEL AUDIO OUTPUT jacks-These jacks are used for connecting to 5.1 channel ready receivers/amplifiers. The label on each jack specifies which speaker in the surround sound system the output signal from the labeled jack is sent to: FL-front left, FR-front right, SL-surround left, SR-surround right, CEN-center, SW-subwoofer. The ML jack is the same as the FL jack and is used as the main left output in a stereo system. The MR jack is the same as the FR jack and is used as the main right output in a stereo system.

6.COMPONENT VIDEO OUTPUT - These jacks output VIDEO to a TV monitor via COMPONENT VIDEO cables. COMPONENT VIDEO outputs the different color signals (U/Pb and V/Pr) and luminance signal (Y) separately for high-fidelity in reproducing colors. The description of the component video output connectors may differ depending on the TV set or monitor i.e. Pr/Pb/Y or Cr/Cb/Y or R-Y/B-Y/Y. Component video cables only transmit the video signal, separate cables are needed for audio signals. Please refer to the operating instructions of the TV set or monitor for details.

7.COAXIAL OUTPUT - This digital output is for connecting devices with a COAXIAL cable.

8.VIDEO (RCA) and S-VIDEO OUT jacks - These jacks output video to a display device (TV, TFT, etc.). The VIDEO jack outputs video using an RCA video cable. The S-VIDEO jack uses an S-VIDEO cable. S-VIDEO provides better color separation and better resolution by separating the color and picture signals of a composite-video signal.

9.OPTICAL OUTPUT - This digital out is for connecting devices with an OPTICAL cable. Please make sure to remove the protective cover from this jack prior to connecting an OPTICAL cable. When not using this input, keep the protective cover on to protect it from dust and foreign material.

Descriptions and Functions

Rear panel

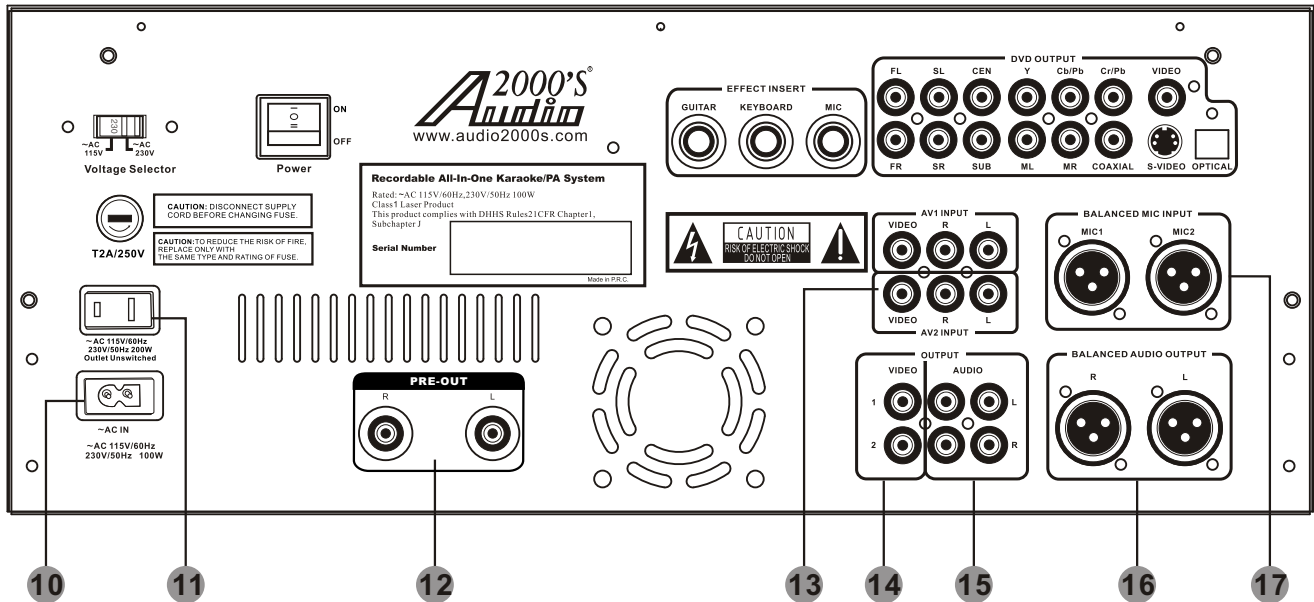

10.AC~IN TERMINAL - Connect AC MAIN POWER CORD from the wall outlet to this terminal.

11.AC POWER outlet - This outlet provides AC POWER to an external device.

Note: Do not connect any device with a power consumption level higher than 200W.

12.PRE-OUT jacks-Connect one end of ¼-inch cables to the left and right PRE-OUT jacks on the AKJ7809. Connect one end of the ¼-inch cables to the left and right AUDIO/LINE/AUX INPUT jacks on the external device.

13.AV 1 / 2 INPUT jacks - These jacks are for connecting AUDIO/VIDEO OUTPUT from external AV SOURCES. Connect RCA-style AV cables (R, W, Y) from these jacks to the AV OUTPUT jacks on your external AV devices.

14.VIDEO OUT 1-2 JACKS (RCA) - These jacks are for connecting the AKJ7809's VIDEO OUTPUT to TV or DISPLAY devices. Connect RCA-type patch cables from these jacks to the VIDEO INPUT jacks on the connecting TV or display devices.

15.AUDIO OUT 1-2 JACKS (RCA) - These jacks are for connecting the AKJ7809 AUDIO OUTPUT to an amplifier, recording or mixing devices. Connect paired RCA-type patch cables from these jacks to the appropriate INPUT jacks on external audio devices.

16.BALANCED AUDIO OUTPUT jacks - These XLR jacks are for connecting MASTER output to an external device with balanced cables.

17.BALANCED MIC 1-2 INPUT (XLR) - These jacks are for connecting microphones via BALANCED XLR-type microphone cables.

Descriptions and Functions

Remote control

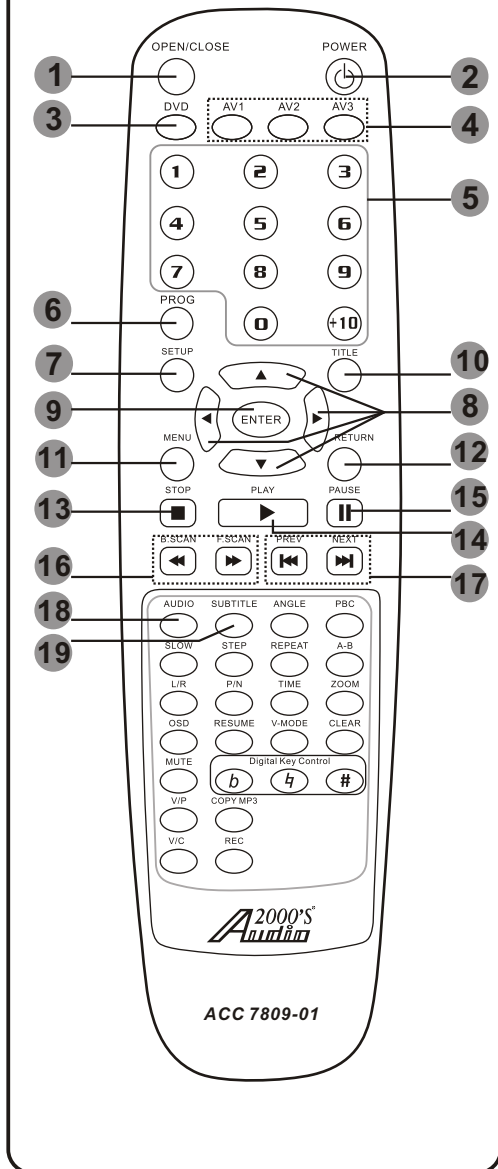

- 1.OPEN/CLOSE** button - This button is used to OPEN/CLOSE the DISC tray.
- 2.Power** button - Turns the AKJ7809 on or to Standby mode. To turn the AKJ7809 completely off, use the power button on the front panel.
Note: The main power must be on in order to use this power button. Turn on the main power with the power button on the front panel.
- 3.DVD** button- This button selects the DVD/USB/SD player as the input to be used.
- 4.AV1/AV2/AV3** button - This button selects the AV1/AV2/AV3 as the input to be used.
- 5.Number/Preset** buttons - Use these buttons to jump directly to a track in Disc mode. See the Disc and Tuner Operations sections of this manual for detailed instructions on using the Number/Preset buttons.
- 6.PROG** button - Please refer to page 14 for the details.
NOTE: The AKJ7809 must be in DISC mode in order to access the PROGRAM menu.
- 7.SETUP** button - Use this button to access the AKJ7809's setup page on the video screen. You can navigate between the General Setup Page, Audio Setup Page, Video Setup Page, preference page and the Password Setup page using the DIRECTIONAL buttons (< ^ > v) on your remote. Select options and make changes using the ENTER button on the remote.
- 8.DIRECTIONAL** buttons- (< ^ > v) - These buttons allow you to navigate through the DVD menu screens, Setup Pages, and Mp3 menus.
- 9.ENTER** button- This button is used to make selections in DVD menus and the OSD when an entry is highlighted.
- 10.Title** button - Accesses the title screen on a DVD.
Note: For use on DVDs with title screens. Some DVDs may not have a title screen.
- 11.Menu** button - Accesses the main menu on a DVD and other discs with main menus.
- 12.Return** button - Accesses the main menu on a VCD 2.0 disc.
Note: PBC must be turned on and the VCD must be a VCD 2.0 disc.
- 13. Stop** button - Stops disc playback in standby mode when pressed once and completely stops disc playback when pressed twice.
- 14. Play** button - Plays a disc that is stopped or paused. See the Operations section in this manual for detailed instructions on auto-scanning.
- 15.Pause** button - Pause a disc that is playing.
- 16.B-Scan and F-Scan** buttons - Scans through a track when in DISC mode: B-Scan scans backwards through the current track and F-Scan scans forwards through the current track
Note:It will not work while playing CDG format disc.
- 17.Prev and Next** buttons - Skip tracks when in DISC mode: prev jumps to the previous track and Next skips ahead to the next track.
- 18.Audio** button - Cycle through caption languages on a disc with multiple caption languages available.
- 19.Subtitle** button - Cycles through the available subtitle languages on a DVD with subtitles available.
Note: Not all DVDs will have subtitles available.

Descriptions and Functions

Remote control

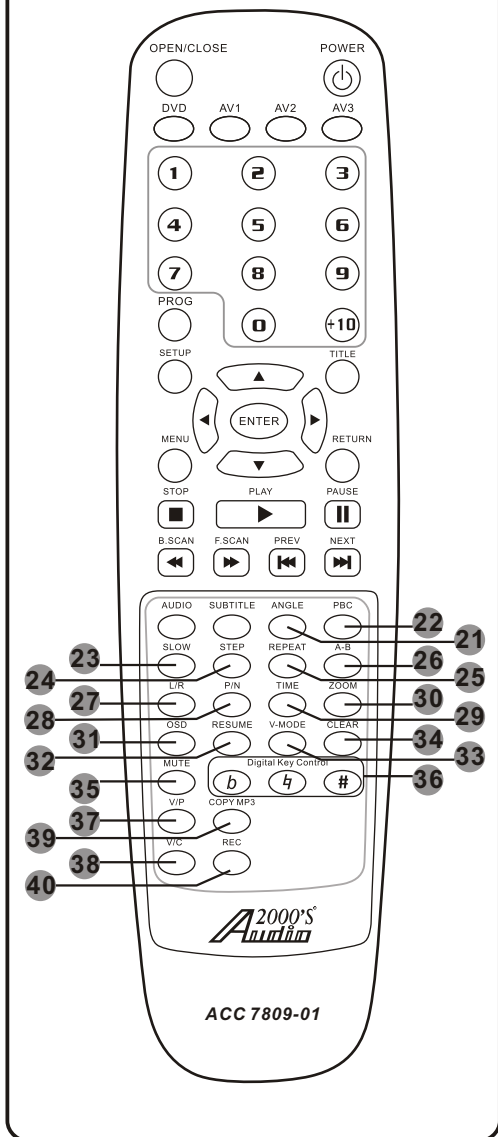

38.V/C (Vocal Cancel) button - In order for this feature to work properly, the disc must be multiplex formatted. Press the VOCAL CANCEL button once to remove the lead vocal layer. Press a second time, and the lead vocal layer will be reestablished.

Note: If you try to utilize this feature while a standard or non-multiplex disc is playing, it will not work as this feature is designed to work with multiplex format discs only.

39.COPY MP3 button - Please refer to page 17 for the details.

40.REC button - Please refer to page 16 for the details.

21.Angle button - Cycles through the available viewing angles on DVDs with multiple viewing angles available.

Note: Not all DVDs will have multiple viewing angles available.

22.PBC button - Turns on Playback Control (PBC). For use with VCD 2.0 discs, PBC allows you to navigate more conveniently through VCD 2.0 discs.

23.Slow button - Cycles through the different slow motion options while in DISC mode. See the Operations section in this manual for detailed instructions on using slow motion.

24.Step button - Allows you to view a disc step-by-step, one frame at a time. See the Operations section in this manual for detailed instructions on using the Step feature.

25.Repeat button - Cycles through the available repeat options. Repeat options vary from type of disc so see the Operations section of this manual for detailed instructions on using the repeat function for every kind of disc.

26.A-B (loop) button - Allows you to set a section on a disc for continuous looping. See the Operations section in this manual for detailed instructions on using the A-B loop feature.

27.L/R button - Cycles through the different multiplex CDG output modes for canceling the vocals: MONO-LEFT, MONO-RIGHT, MIX-MONO and STEREO. See the Operations section in this manual for detailed instructions on canceling vocals on multiplex CDG discs.

28. P/N button - Switches between PAL and NTSC video modes.

29.Time button - Accesses the Time menu which allows you to jump directly to a specific time on a disc. See the Operations section in this manual for detailed instructions on jumping to a specific time on a disc.

30.Zoom button - Allows you to zoom in 2X, 3X and 4X and zoom out 1/2X, 1/3X and 1/4X on the video during disc playback.

31.OSD button - Cycles through the different On Screen Display options. See the Operations section in this manual for detailed instructions on selecting OSD options.

32.Resume button - Resumes playback from exact spot where a disc has been stopped in standby mode.

33.V-MODE - This button toggles between the different variants of component video, YUV (US), and S- Video.

34.Clear button - Clears any numbers typed into a menu before a selection has been made.

35.Mute button - Mutes the sound from disc, ipod and AV input channels.

36.DIGITAL KEY CONTROL - These buttons direct the DIGITAL KEY CONTROLLER

- # - Raises the musical key a quarter-step each time this button is pressed.
- h - Resets the musical key to it's original key.
- b - Lowers the musical key a quarter-step each time this button is pressed.

Note: This feature is not applicable to the AUX inputs, AV1/AV2/Av3.

37.V/P (Vocal Partner) button - To activate VOCAL PARTNER, press button once. To remove VOCAL PARTNER, press a second time. NOTE: If you try to utilize this feature while a standard or non-multiplex disc is playing, it will not work as this feature is designed to work on multiplex format discs only.

Descriptions and Functions

Remote control

Using the remote control

When operating the remote control, point the top of the remote control toward the AKJ7809's remote sensor on the front panel and ensure that there is a clear line of sight between the remote control and AKJ7809 void of obstacles in order to prevent signal deflection.

When to replace the batteries

The maximum operational distance between the remote control and the sensor is approximately 25 feet. If the remote only operates at shorter distances, it is time to replace the batteries.

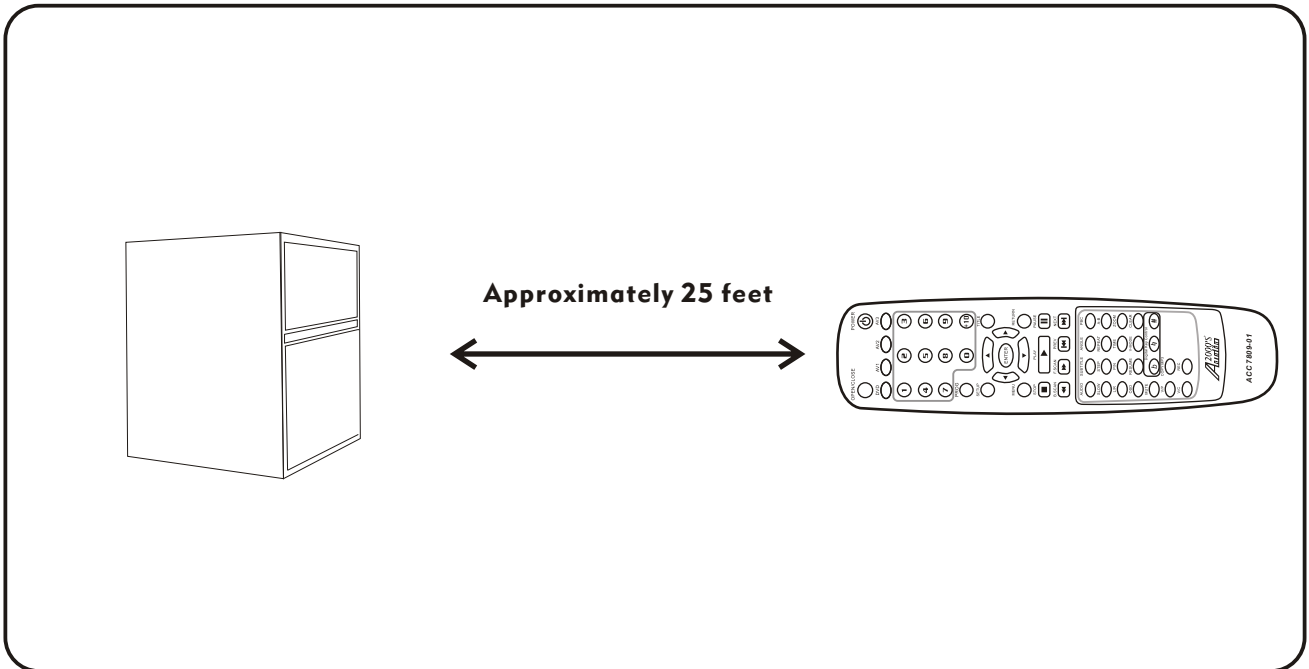

Installing the batteries

To install the batteries, first remove the battery compartment lid from the back of the remote control. Insert two AAA batteries, ensuring that the polarities are aligned correctly.

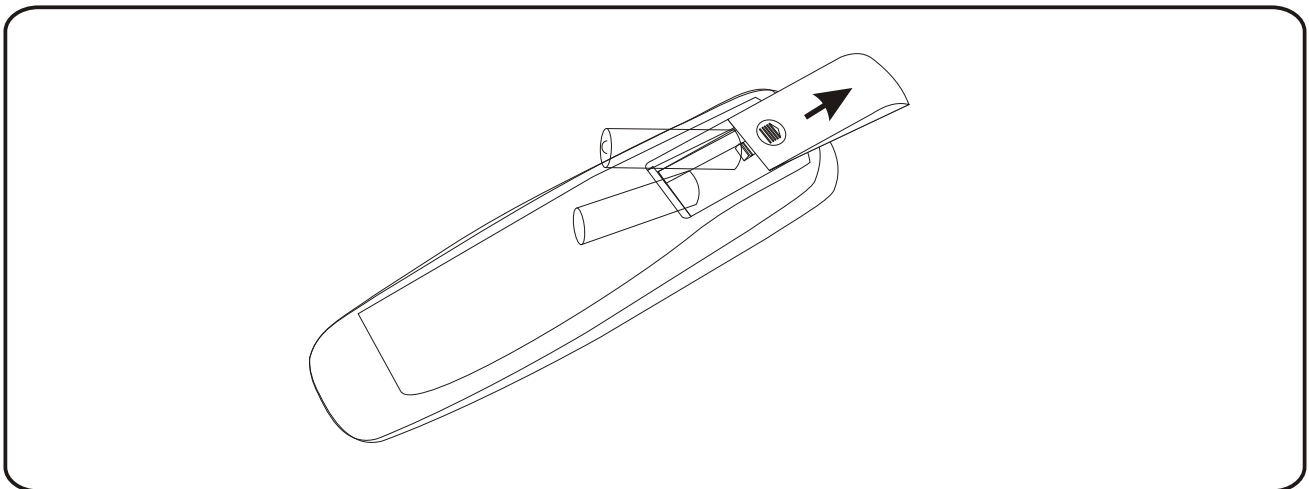

DVD System Setup Menu

SYSTEM SETUP MENU

To access the System Setup Menu, press the SETUP button on the remote control. The menu will appear on the TV screen. Use the arrow buttons on the remote control to navigate through the menu and use the ENTER button to make selections.

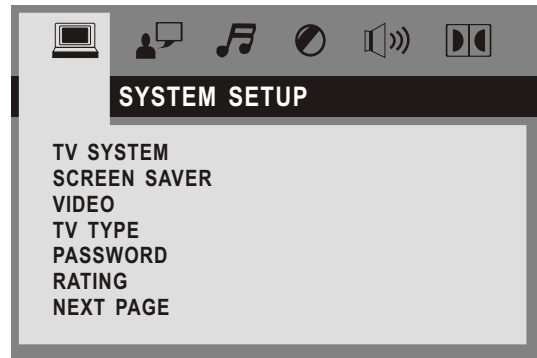

1. TV SYSTEM

Set the video output to your TV's system format:

- NTSC North America
- PAL Europe, Asia
- PAL60 This format enables a PAL TV/Monitor to play the NTSC video.
- AUTO Automatically detects the TV's format.

2. SCREEN SAVER

The DVD screen saver can be toggled ON or toggled OFF to suit your preference for display during extended periods of player inactivity when power remains on. Use the Directional buttons (< > ^ ^) to make your selection.

3. VIDEO

Refer to your TV manual to determine which type of video it supports. You can choose between INTERLACE-YUV, P-SCAN YPBPR or S-VIDEO.

4. TV TYPE

This menu actually refers to TV display mode. Choose between 4:3PS for Panoramic Screen, 4:3LB for Letterbox, or 16:9 based on your viewing preference.



To view the standard 4:3 picture or the cut standard 4:3 picture



4:3 subtitle block to view the full width of the widescreen mode



16:9 To view widescreen picture with a widescreen TV set

Standard TV set

Widescreen TV set

NORMAL/PS

NORMAL/LB

WIDE

5. PASSWORD

When the PASSWORD menu is selected, the displayed lock icon is closed (locked) as shown in Fig (1). The preset password to lock or unlock RATING settings is 0000. If you are a parent and want to limit the types of DVD's to be viewed with the AKJ7809, type this password using the NUMBER keys on the remote, and then press ENTER to unlock the RATING setting. Once you unlock the RATING setting, the lock icon will be opened (unlocked) as shown in Fig (2).



Fig(1)

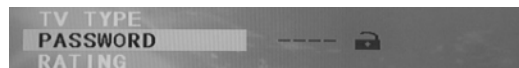

Fig(2)

With the RATING setting unlocked, enter the RATING menu and select the desired parental safety setting, then come back to the PASSWORD menu to enter a desired 4-digit password to lock the selected parental safety setting. A locked icon as in Fig (1) will display to indicate the locking status.

6. RATING

Set the parental safety settings. There are eight (8) parental safety settings as displayed on the TV / monitor.

DVD System Setup Menu

7. NEXT PAGE

7.1 DEFAULT

Select this mode if you choose to return all system preferences to the DEFAULT settings.

7.2. RESUME

- ON:RESUME the last spot played on a disc and returns to it when the AKJ7809 is turned back on from the Standby mode.
- OFF:RESUME is off.

7.3. PREV PAGE

LANGUAGE SETUP

This menu is used to set up the language preferences for the functions described as follows. Use the Directional buttons (< > ^ ^) on the remote control to navigate through the menu and use the ENTER button to make selections.

1. OSD (On Screen Display) Language

The available OSD languages include English, Spanish, French, German, Portuguese, and Chinese.

2. AUDIO LANGUAGE

This feature is dependent upon the options included with each individual disc. Choose from the list provided by the disc.

3. SUBTITLE LANGUAGE

This feature is dependent upon the options included with each individual disc. Choose from the list provided by the disc.

4. MENU LANGUAGE

This feature is dependent upon the options included with each individual disc. Choose from the list provided by the disc.

AUDIO SETUP

1. AUDIO OUT

The AKJ7809 allows user to use the standard analog audio outputs and the digital output simultaneously by using the RCA L/R outputs and the coaxial output. When the AKJ7809 is connected to an external sound system with digital inputs, select settings as follows:

- (a) SPDIF/OFF This setting completely disables the digital audio output.
- (b) SPDIF/RAW This setting selects the Dolby 5.1 digital audio output. (optical- coaxial)
- (c) SPDIF/PCM This setting selects the stereo digital audio output (2 channels)

2. KEY CONTROL

This feature functions exactly the same as the KEY CONTROL buttons on the remote control, but with a virtual vertical fader instead of a left-right display. Use the Directional buttons (< > ^ ^) on the remote control to the fader bar and raise (# or sharp) or lower (b or flat) the output of the disc in quarter-step increments.

VIDEO SETUP

Use the Directional buttons (< > ^ ^) to raise or lower the vertical fader bars to set up the following video preference settings.

1. **BRIGHTNESS** - Adjust the brightness of the display.
2. **CONTRAST** - Adjust the contrast of the display.
3. **HUE** - Adjust the hue of the display.
4. **SATURATION** - Adjust the saturation of the display.

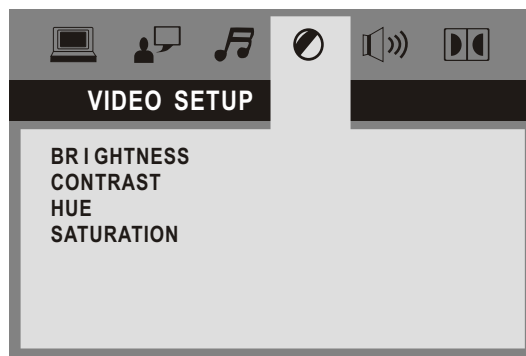
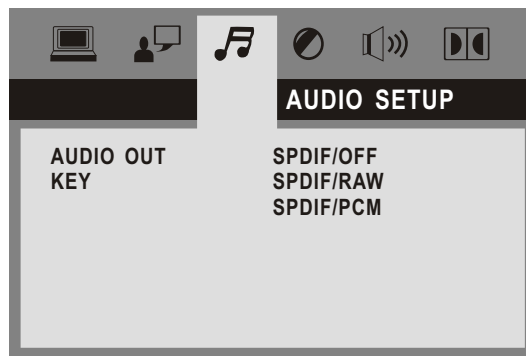
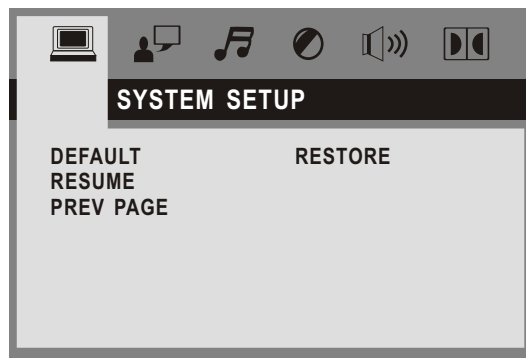

DVD System Setup Menu

SPEAKER SETUP

1. DOWNMIX

- **LT/RT** - The left channel and the right channel sound outputs are mixed first and then the mixed sound output is redirected to the left speaker and the right speaker simultaneously.
- **STEREO** - Sound output is in Stereo Mode.
- **V SURR** - Virtual Surround Sound.
- **5.1 CH** - For 5.1 Channel surround sound.

2. SUBWOOFER

- **ON**: If you have a subwoofer.
- **OFF**: If you do not have a subwoofer.

3. CENTER DELAY

4. REAR DELAY

5. FRONT

Set this based on the size of your front speaker.

- **LARGE**
- **SMALL**

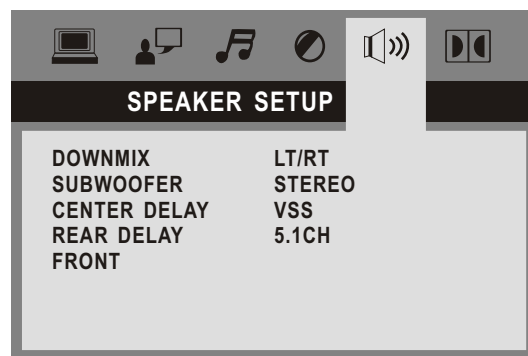

DIGITAL SETUP

1. OP MODE

LINE OUT - This setting compresses the output signal and lowers the volume for use in a quieter environment, such as at night time.

RF REMOD - This setting increases volume for regular usage.

2. DYNAMIC RANGE

When the OP CODE is set to LINE OUT, use this setting to select the ratio of signal compression. Select FULL for the lowest maximum signal and OFF for the highest maximum signal.

3. DUAL MONO

- **STEREO** - This setting plays the disc audio in the stereo mode.
- **MONO L** - This setting plays only the left audio channel.
NOTE: For use only on Multiplex CDG discs.
- **MONO R** - This setting plays only the right audio channel.
NOTE: For use only on Multiplex CDG discs.

- **MIX MONO** - This setting plays the disc audio in the mixed audio mode in which the left audio channel and the right audio channel are mixed first and then redirected to the left channel and the right channel simultaneously.

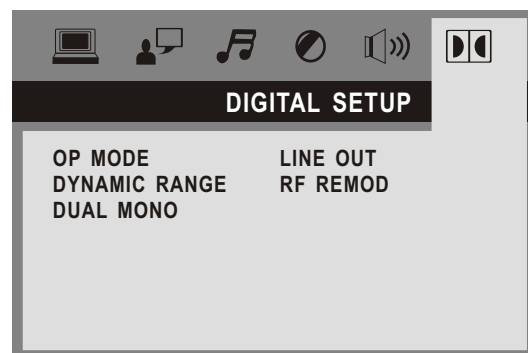

Troubleshooting

Troubleshooting

1. There is no power

- Make sure the power cord is firmly connected to the back of the AKJ7809 and to the power outlet
- If using a power strip/surge-protector, make sure that it is plugged in and switched on
- Make sure the Power button on the front panel is pushed in to the on position

2. There is no sound

- Make sure everything is connected firmly and properly
- Make sure all of your components are turned on
- Make sure the AKJ7809 is set to the right input
- Make sure the proper volume controls are turned up high enough

3. No picture

- Make sure everything is connected firmly and properly
- Make sure there are no defective cables
- Make sure all of your components are turned on
- Make sure the AKJ7809 is set to the right input
- Make sure the TV or monitor is working correctly

4. The disc does not play

- Make sure the disc is inserted correctly (label-side up)
- Make sure the disc is clean and not scratched
- If using a CD/DVD R/RW, try using a different brand as some brands might not be compatible
- Clean the CD lens using a CD lens cleaner

5. Remote control does not work

- Make sure the batteries are inserted, inserted correctly, and not out of power
- Point the remote control directly at the remote sensor on the machine
- Move closer to the machine

6. The picture is unclear

- Make sure the disc is not dirty or damaged
- Make sure that the TV TYPE (P/N button on the remote) is set correctly:
NTSC: In North America, Japan and many other Asian countries
PAL: In Europe
- Try restarting the AKJ7809

7. The Music from an MP3 player or CD sounds hollow or very reverby

- Make sure the surround sound quality, using the SURROUND button on the remote control or front panel, is set to MUSIC

Service Information

SHIPPING DAMAGE

If the shipping carton is found to be damaged, notify the delivery company immediately. Save the damaged carton as evidence for the delivery company to inspect. It is the responsibility of the shipper to file a claim with the delivery company for any damage that occurs during shipping. In the case that the shipping carton is in good condition but the unit is damaged or defective, call **Audio2000'S®** at 805-523-2759.

FACTORY SERVICE

If the equipment needs factory service, call **Audio2000'S®** at 805-523-2759 for a Return Authorization number (RA number) and the address of the authorized service representatives. Insure and ship the product, prepaid, in its original carton along with proof of purchase in the form of a bill of sale or receipted invoice to the above address. Please clearly write the RA number on the shipping carton. Also enclose a note describing the problem along with any other helpful information such as where and how the unit was used.

LIMITED WARRANTY

H&F Technologies, Incorporated (H&F) hereby warrants that **Audio2000'S®** products will be free from defects in material and workmanship for a period of 1 (one) year from date of purchase. At its option, H&F will repair or replace the defective product and promptly return it to you.

The Limited Warranty will not cover any item that has been, in H&F's estimation, subject to alteration, misuse, neglect, accident or improper installation. In addition, any service not performed by H&F or an authorized service center will terminate terms of this warranty. Normal wear and tear of this product will not be covered by this or any implied warranty.

No liability will be accepted for damages/loss directly caused from the use of this product. H&F's liability shall be limited to the repair/replacement of this product if found to be defective.

© 2009 H & F Technologies, Incorporated (website: www.audio2000s.com)